

TABLE OF CONTENTS = TOOLS =

CORE TOOLS:

Peghole Reamers & Accessories	H2 - H5
Peghole Shapers & Accessories	H6 - H11
Endpin Reamers	H12 - H13
Clamps	H14 - H29
Soundpost Tools	H30
String Lifters, Drilling Jigs, Bridge Leg Expander	H31
Fingerboard Pads, Digital Caliper	H31
Knives	H32 - H33
Scrapers	H34
Gouges & Chisels	H35
Files & Rasps	H36 - H37
Patterns / Instrument Templates	H38 - H39
Planes	H40 - H41
Purfling Router, Razor saws	H42
Miscellaneous Violinmaker Tools	H43 - H44
Bowmaker Tools	H44
Other Tools (see Table of Contents p. H45)	H46 - H78
Updates (electronic version only).....	H79



Use QR code to open this
section online!

*Please Note:
Images of items displayed herein are not to scale*



REAMERS - PEG HOLE REAMERS

CORE® Reamers provide a diverse range of suitable tools for various peg-fitting needs, ensuring comprehensive solutions for every purpose.

CORE reamers are crafted from HSS (High-Speed Steel), allowing for hardening treatment to attain exceptional hardness levels, approximately 65 HRC. HSS also exhibits high resistance to abrasive edge wear. The violin reamers feature a 1:30 taper, while the cello reamers boast a 1:25 taper. Luthiers who favor a 1:20 taper can opt for the "slim tip" modification. Those working with partial-size instruments can choose the "small" modification. Additionally, there's a modification specifically designed for gamba.

CORE® Peghole Reamers are made in four modifications: with straight or spiral-shaped cutting edge and with or without TiN coating.

Various modifications are specifically tailored for distinct purposes. The straight modification, with a slightly higher cutting-edge angle, is ideal for precisely calibrating and cleaning existing peg holes. On the other hand, the spiral modification is designed for reaming new holes, leveraging its spiral geometry to prevent ovality and shifting during the tapering process of the original cylindrical hole. The TiN coating plays a crucial role in preventing micro-corrosion of the cutting edge, thereby enhancing the overall durability of the cutting edge.



CT-833.706



CT-833.716



CT-833.726



CT-833.736

PEG HOLE REAMERS - VIOLIN / VIOLA - TAPER 1:30

Reamers for violins and violas typically have a 1:30 taper and come in two lengths: 135mm and 105 mm. The "small" variant is designed for fractional instrument sizes as tiny as 1/16. HSS, 63 HRC.

NO.	DESCRIPTION	\$-NET
CT-833.706	Peg Reamer Violin Standard. Taper 1:30 10/5.5mm Length 135mm Straight Uncoated	111.78
CT-833.716	Peg Reamer Violin Standard. Taper 1:30 10/5.5mm Length 135mm Straight Tin Coated	130.41
CT-833.726	Peg Reamer Violin Spiral. Taper 1:30 10/5.5mm Length 135mm Uncoated	131.96
CT-833.736	Peg Reamer Violin Spiral. Taper 1:30 10/5.5mm Length 135mm Tin Coated	153.70
CT-833.708	Peg Reamer Violin Small. Taper 1:30 7.5/4.0mm Length 105mm Straight Uncoated	99.36
CT-833.715	Peg Reamer Violin Small. Taper 1:30 7.5/4.0mm Length 105mm Straight Tin Coated	111.78
CT-833.728	Peg Reamer Violin Small. Taper 1:30 7.5/4.0mm Length 105mm Spiral Uncoated	108.68
CT-833.735	Peg Reamer Violin Small. Taper 1:30 7.5/4.0mm Length 105mm Spiral Tin Coated	131.96

PLEASE INQUIRE ABOUT
QUANTITY DISCOUNTS



REAMERS - PEG HOLE REAMERS

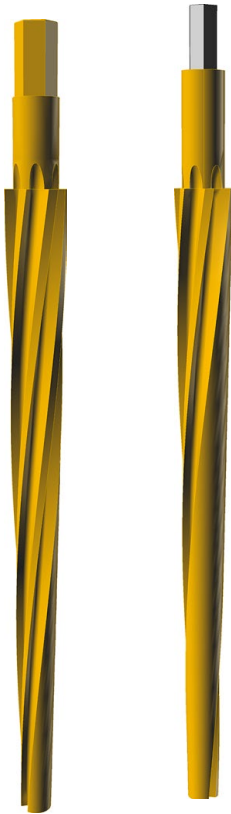

¼" hex instead of a traditional handle allows the use of a power tool (screwdriver). This not only enhances productivity, but also enables perfection, as a steady rotating motion is less sensible to create ovality than a repeated hand stroke while using a traditional handle.

For individuals who favor power driving (which we highly recommend), we offer modifications with a ¼" hex instead of a handle variant. These reamers can be easily inserted into the standard chuck of a power drill, but they work even more seamlessly with a ¼" attachment on a power drill. However, a classical handle with a ¼" attachment is also available for those who prefer traditional handwork.

Taper Pins for violins are offered in 1:20 and 1:30, while those for cellos come in 1:25.

The process of making a precise peg hole is finished using a taper pin. Rotating the pin in the peg hole, even with peg soap on its surface will deburr, sleek and evenly impregnate the inner surface of the peg hole, especially when the peg action is demanded in the highest accuracy for professional players.



TAPER PINS / BURNISHERS

NO.	DESCRIPTION	\$-NET
CT-833.729	Taper Pin 1:20 Violin 10/3.5mm Length 130mm	77.46
CT-833.725	Taper Pin 1:30 Violin 10/4.5mm Length 165mm	85.39
CT-833.826	Taper Pin 1:25 Cello 15/6.0mm Length 225mm	153.70

TOOLS



REAMERS - PEG HOLE REAMERS



CT-833.707



CT-833.737

PEG HOLE REAMERS - VIOLIN / VIOLA - SLIM TAPER 1:20

The violin/viola reamers with the "SLIM TIP" modification have a 1:20 taper. Some antique violins from the 17th and 18th centuries still have this asymmetrical taper that has recently been used. By combining the CORE "SLIM TIP" reamer and the CORE adjustable peg shaper (CT-833.604), makers can swap out pegs without having to re-ream the peg holes. HSS, 63 HRC.

NO.	DESCRIPTION	\$-NET
CT-833.707	Peg Reamer Violin Slim Tip Taper 1:20 10/3.5mm Length 130mm Straight Uncoated	116.44
CT-833.727	Peg Reamer Violin Slim Tip Taper 1:20 10/3.5mm Length 130mm Spiral Uncoated	116.44
CT-833.737	Peg Reamer Violin Slim Tip Taper 1:20 10/3.5mm Length 130mm Spiral Tin Coated	139.73



CT-833.616

(SHOWN WITH HANDLE
ITEM #CT-803.602)



CT-833.618

PEG HOLE REAMERS - VIOLIN / VIOLA - 1/4" HEX HEAD

Instead of a conventional handle, a 1/4" hex facilitates the use of a power drill. This increases output and improves accuracy since a constant rotating action is less likely to yield defects than a series of hand strokes with a conventional handle. This modification is available with either a standard or a slightly rounded cutting edge, which produces an incredibly smooth inner surface for the peg hole. The usage of stop rings (833.638 and other models) is advised while using a power drill. The conventional handle can still be used to operate the 1/4" hex reamers (item CT-833.602). HSS, 63 HRC.

NO.	DESCRIPTION	\$-NET
CT-833.616	Peg Reamer 1/4 Hex Shaft Violin Standard Taper 1:30 10/5.5mm Length 135 Spiral Tin Coated	153.70
CT-833.618	Peg Reamer 1/4 Hex Shaft Cello Taper 1:25 16/8.0mm Length 200 Spiral Tin Coated	263.93

REAMER HANDLES

With 1/4" hex attachment.

NO.	DESCRIPTION	\$-NET
CT-803.602	Padauk Handle For Hex 1/4 Inch Reamers Violin	13.97
CT-803.603	Padauk Handle For Hex 1/4 Inch Reamers Cello	13.97



CT-803.602



REAMERS - PEG HOLE REAMERS



CT-833.805



CT-833.825

**IMAGE
COMING SOON!**

CT-833.815

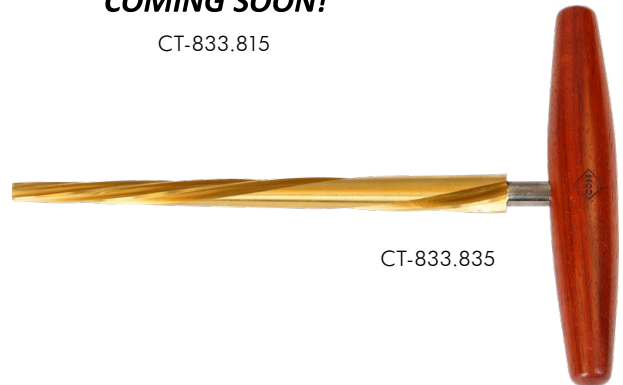

CT-833.835

**IMAGE
COMING SOON!**

CT-833.709

PEG HOLE REAMERS - CELLO - STANDARD TAPER 1:25

The conventional taper for cello reamers is 1:25, which is typically the same taper used for Gamba/Lute pegs. HSS, 63 HRC.

NO.	DESCRIPTION	\$-NET
CT-833.805	Peg Reamer Cello Taper 1:25 16/8.0mm Length 200mm Straight Uncoated	173.88
CT-833.815	Peg Reamer Cello Taper 1:25 16/8.0mm Length 200mm Straight Tin Coated	195.62
CT-833.825	Peg Reamer Cello Taper 1:25 16/8.0mm Length 200mm Spiral Uncoated	200.27
CT-833.835	Peg Reamer Cello Taper 1:25 16/8.0mm Length 200mm Spiral Tin Coated	225.11
CT-833.709	Peg Reamer Violin, Lute Gamba Taper 1:25 12/4.0mm Length 200mm Straight Uncoated	200.27



CT-833.618

PEG HOLE REAMERS - CELLO - 1/4" HEX HEAD

¼" hex instead of a traditional handle allows the use of a power tool (screwdriver). This not only enhances productivity, but also enables perfection, as a steady rotating motion is less prone to create ovality than a repeated hand stroke while using a traditional handle. This modification is available in two different shapes of the cutting edge: either a regular or a slightly rounded edge, which creates a super fine-finished inner surface of the peg hole. In the case of the use of a power tool, the use of stop rings (CT-833.641 and others) is recommended.

NO.	DESCRIPTION	\$-NET
CT-833.618	Peg Reamer 1/4 Hex Shaft Cello Standard Taper 1:25 16/8.0mm Length 200 Spiral Tin Coated	195.50

REAMER STOP RINGS

Stop rings are valuable tools that help to adjust the reamer depth so that the peg hole adapts a peg of the desired diameter under the collar for a 13 mm clearance. (Especially advisable when using a power drill for driving the reamer).

NO.	DESCRIPTION	\$-NET
CT-833.422	Stop Ring For Reamer 7.8mm	10.08
CT-833.423	Stop Ring For Reamer 8.2mm	10.08
CT-833.634	Stop Ring For Reamer 7.2mm	10.08
CT-833.635	Stop Ring For Reamer 7.5mm	10.08
CT-833.639	Stop Ring For Reamer 8.0mm	10.08
CT-833.641	Stop Ring For Reamer 12.2mm	10.08



CT-833.422



CT-833.634



CT-833.639



CT-833.423



CT-833.635



CT-833.641



PEG SHAPERS & ACCESSORIES

Having the right peg action is crucial when deciding to buy a violin. If the pegs don't work smoothly, it can be frustrating, even if the violin itself sounds great.

CORE® Peg shapers are the best tools available, and CORE Tools always strives to improve their technology.

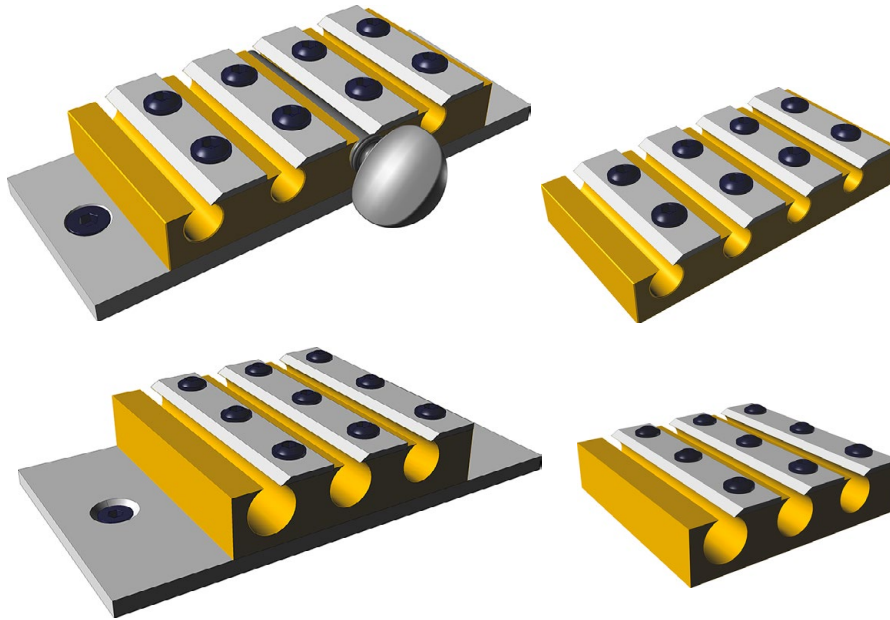

CORE® Standard Violin Peg shapers are designed with specific collar diameters, ranging from 10 to 8.5 mm and 8 to 6.5 mm, following a standardized 1:30 taper. Additionally, you can attach an optional base plate to the tool's base, making it easier to secure the pegshaper to a workbench using screws or clamps. This feature frees the luthier's hands, improving precision and ease of use, and potentially allowing the use of a power tool.

CORE® Standard Cello Peg shapers follow the same principles as violin modifications. They come pre-set with collar diameters ranging from 14.5 to 13 mm and 12.2 to 10.7 mm, respectively, in line with a standardized cello taper of 1:25. Additionally, an optional base mounting plate is available as an accessory for this model.

Experience the exceptional benefits of CORE® pegshapers when you remove the end blade screws. The setup and adjustment of CORE pegshapers are significantly easier and more precise than other options on the market. How does it work? The blades are precisely positioned on circular cams. You can adjust the blade inward or outward on each side by simply turning these cams. These subtle movements allow for fine-tuning the diameter and taper of the peg shaft. Even after blade resharpening, adjusting the diameter is effortlessly achieved with a small turn of the cam. This level of precision and convenience distinguishes CORE pegshapers from the rest.

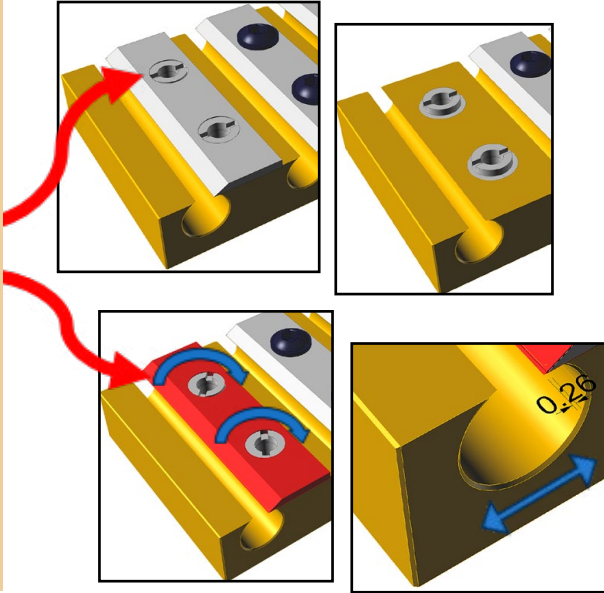

TOOLS

STANDARD PEG SHAPERS

Brass body, HSS blades.

NO.	DESCRIPTION	\$-NET
CT-833.305	Peg Shaper Violin Small. 51mm shaft length. Peg diameters: 8.0, 7.5, 7.0, 6.5	189.28
CT-833.306	Peg Shaper Violin Regular. 51mm shaft length. Peg diameters: 10.0, 9.5, 9.0, 8.5	189.28
CT-833.406	Peg Shaper Cello Small. 81mm shaft length. Peg diameters: 12.2, 11.5, 10.7	189.28
CT-833.405	Peg Shaper Cello Regular. 81mm shaft length. Peg diameters: 14.5, 13.7, 13.0	189.28

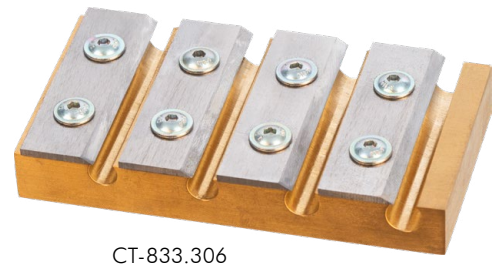

CT-833.306



While Standard Peg shapers have strictly preset diameter and taper, the **CORE® Universal Peg shaper** is intended to produce any diameter between 7mm and 9.5mm, and tapered 1:20 to 1:35. This variability is especially useful when restoring antique violins, and the luthier is not willing to re-ream the peg holes and wants to fit the new pegs into the original holes.

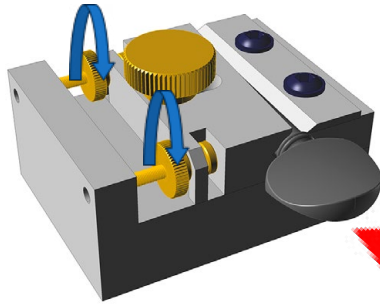

You can easily adjust the diameter and taper with two knurled screws. After that, make sure to secure the guide block's position with the master screw.

UNIVERSAL PEG SHAPER

Aluminum body, HSS blade, brass screws, adjustable 7-9.5 mm, 1:20 to 1:35

NO.	DESCRIPTION	\$-NET
CT-834.004	Universal Peg shaper Violin	189.28



CT-834.004

The **CORE® Mini Peg shaper** is preconfigured at the factory with dimensions of 7.8 and 8.2 mm, conforming to a 1:30 taper. These measurements correspond to the most commonly used dimensions for pegs in new violins. This tool is highly effective in a workshop setting, especially when standardizing pegs for a larger number of instruments before their installation.

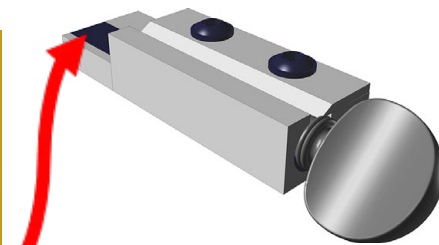

The Mini pegshaper can be easily clamped onto a workbench with any clamp on hand.



CT-833.415

MINI PEG SHAPERS

Single-purpose pegshaper with factory settings to 7.8 mm resp 8.2 mm. Aluminum body, HSS blade

NO.	DESCRIPTION	\$-NET
CT-833.415	Mini Peg Shaper Violin 7.8mm	66.08
CT-833.416	Mini Peg Shaper Violin 8.2mm	66.08



CT-833.416

TOOLS



PEG SHAPERS & ACCESSORIES

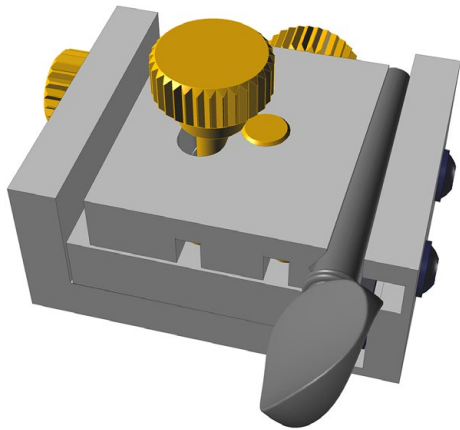

The CORE® Precise Peg shaper is the most advanced tool in the CORE lineup, designed for shaping pegs with unparalleled precision by adjusting the peg's diameter and fine-tuning the taper. It's ideal for achieving the finest peg adjustments.

The peg's diameter is adjusted simply by exchanging the guide block. Fine-tuning the diameter, considering the type of wood used for the peg, is achieved with the fine adjustment screw, which moves the guide block forward and backward. Additionally, the taper can be adjusted by the taper adjustment screw, within a range of $\pm 0.8^\circ$, depending on the wood type.

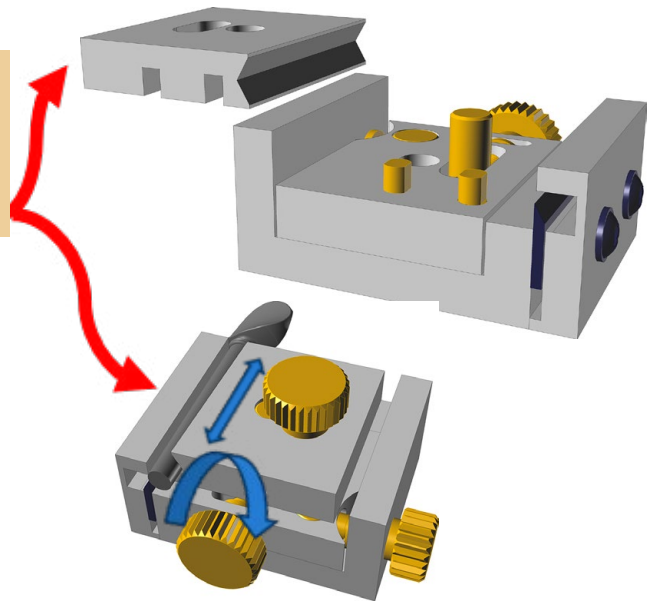
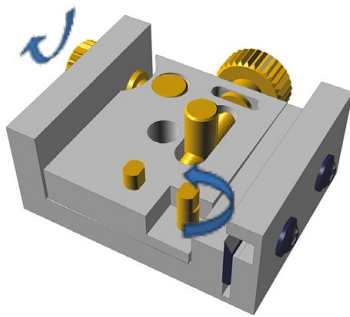

PRECISE PEG SHAPER

Aluminum body, HSS blade, brass screws.

NO.	DESCRIPTION	\$-NET
CT-806.454	Precise Peg Shaper Violin 8.2mm.	256.48



CT-805.454

All CORE® Peg shapers utilize identical blades, each with a 1.8 mm thickness made of solid High-Speed Steel (HSS). HSS is chosen for its exceptional wear resistance and ease of regrinding.

PEG SHAPER BLADES

NO.	DESCRIPTION	\$-NET
CT-883.305	Blade Mk1 For Core Violin Peg Shaper	29.50
CT-883.405	Blade Mk3 For Core Cello Peg Shaper	31.05
CT-883.406	Blade Mk2 For Core Violin Peg Shaper HSS Solid	29.50

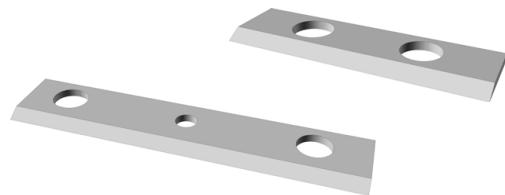

IMAGE COMING SOON!



PEG SHAPERS & ACCESSORIES

BASE PLATE FOR STANDARD PEG SHAPERS

NO.	DESCRIPTION	\$-NET
CT-833.307	Base plate for violin shaper	11.09
CT-833.407	Base plate for cello shaper	11.09

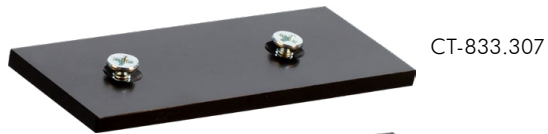

CT-833.307



CT-833.407

GUIDE BLOCK FOR PRECISE PEG SHAPERS

NO.	DESCRIPTION	\$-NET
CT-806.455	Guide block for Precise Peg Shaper 7.2mm	17.92
CT-806.456	Guide block for Precise Peg Shaper 7.5mm	17.92
CT-806.457	Guide block for Precise Peg Shaper 7.8mm	17.92
CT-806.458	Guide block for Precise Peg Shaper 8.5mm	17.92
CT-806.459	Guide block for Precise Peg Shaper 8.8mm	17.92

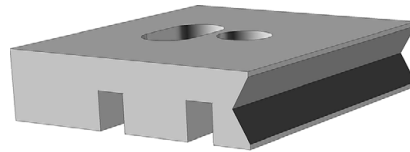

PEG ENDING TOOL

Achieving a finely rounded and polished peg-end is a meticulous process that may appear deceptively simple. The CORE Peg-end Finishing Gadget significantly simplifies and standardizes this task, making it both more efficient and consistently replicable.

The tool adjusts between 36-44 mm by screwing the inner holder in or out of the outer sleeve. The sleeve has a stainless steel socket with a rounded end (radius: R3/8"). This helps the luthier create pegs with a set length and a neat ball-end.

NO.	DESCRIPTION	\$-NET
CT-833.418	Peg Ending Tool	84.00



CT-833.418

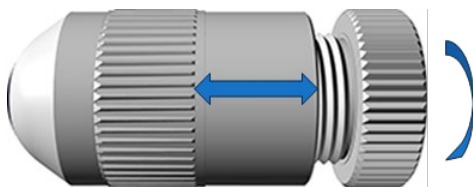

1. Choose the preferred peg length.
2. Insert the peg into the gadget; the rubber O-rings will secure it in place.
3. Trim the peg to the desired length and shape the ball end using a file and sandpaper. The gadget's face ring, made of stainless steel, withstands wear from shaping tools.
4. Easily polish the ball end using the gadget.

PEG SHAPER DRIVERS

NO.	DESCRIPTION	\$-NET
CT-833.310	Peg Shaper Driver - Violin	42.56
CT-833.311	Peg Shaper Driver - Cello	50.40



CT-833.310

CT-833.311



PEG SHAPERS & ACCESSORIES

Creating a universal pegshaper is a continual and time-consuming process. The CORE® Tools team has developed a tool that eliminates all challenges associated with pegshaver setup. The CORE® Peg shapers **New Concept** addresses all weaknesses in pegshaver setup.

The CORE® **New Concept Violin Peg shapers** come in calibrated sizes (10 to 8.5 mm and 8 to 6.5 mm) with a standardized 1:30 taper. An optional base plate, attachable to the tool's base, allows secure fixation to a workbench using screws or clamps. This frees the luthier's hands, improving precision and ease of tasks, and potentially enabling the use of a power tool.

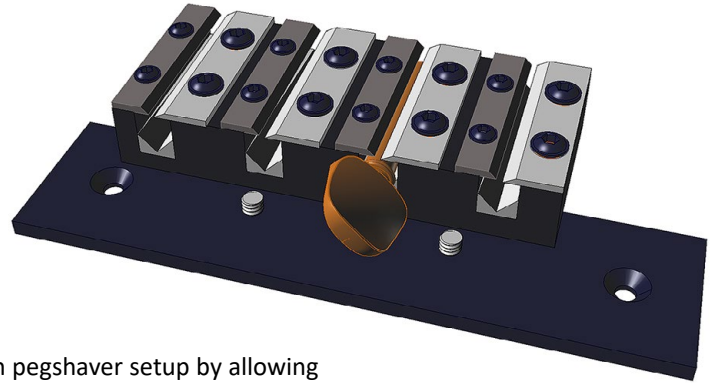

The CORE® Peg shapers **New Concept** addresses the shortcomings in pegshaver setup by allowing independent adjustment of three crucial parameters:

1. **Cutting conditions:** The depth of the cut plays a vital role in achieving the desired surface quality for the peg shaft, with the optimal range being 0.08-0.1 mm.
2. **Diameter under the collar:** This parameter ensures the overall thickness of the peg shaft.
3. **Cone taper:** Conforming to the reamer's taper (usually 1:30 for violin and 1:25 for cello) is essential. The proper peg action is guaranteed when the thinner end is a few hundredths of a millimeter thinner than the nominal dimension.

The new CORE® **New Concept** Peg shapers empower users to independently set these three parameters, enhancing precision in pegshaver customization.

The HSS blade is secured by two circular cams. By unscrewing the securing screws and rotating these cams, both ends can be independently moved transversally to achieve the ideal shaving depth. This step also includes a rough adjustment of the taper. Once the desired positions are achieved, the securing screws are tightened, ensuring the blade remains fixed even after regrinding.

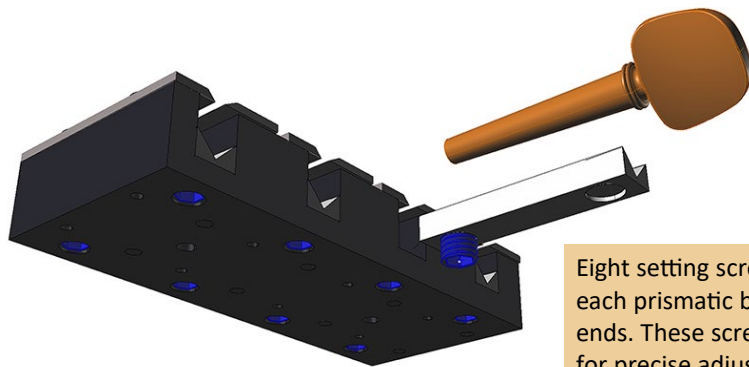
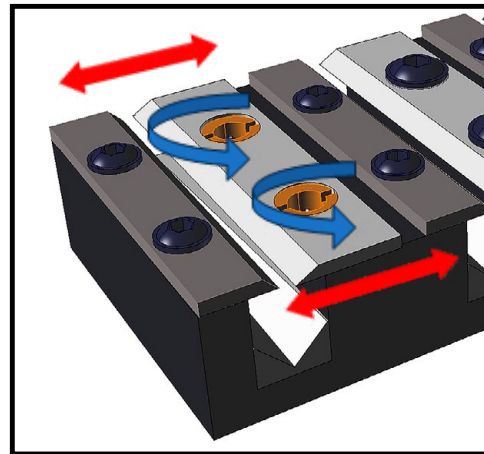

Eight setting screws support each prismatic bed at both ends. These screws allow for precise adjustments, enabling the setting of both the diameter under the collar and the correct taper of the peg.

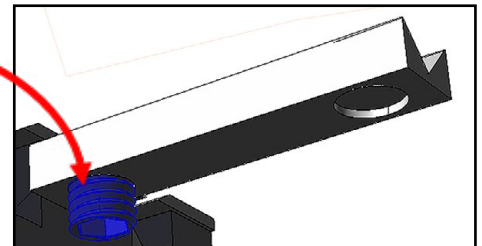

PEG SHAPERS & ACCESSORIES

The **New Concept Cello Peg shapers** come in two dimensional lines:

- 1. Large with diameters 14.0, 12.7, 11.5 mm
- 2. Small with diameter 13.2, 12.0, 10,8 mm

The setting screws enable to reduce the diameter by 0.4 mm.

The cello version of the **CORE® New Concept Peg shaper** follows the same principle as the violin version:

- Two circular cams facilitate the adjustment of shaving depths by transversally moving both ends of the blade.
- Six setting screws allow for precise adjustments of the diameter under the collar and the taper.

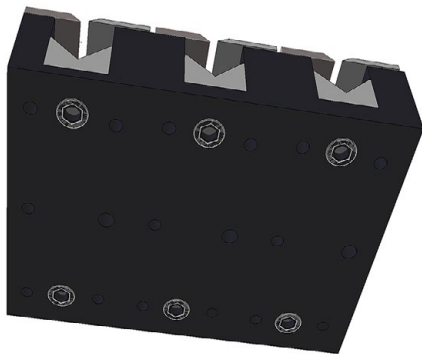
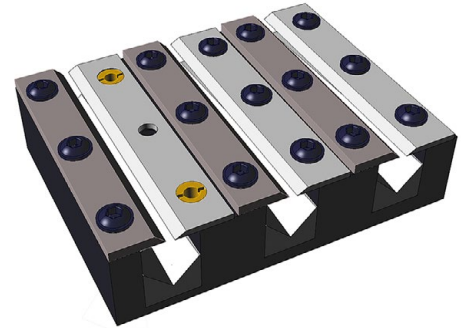

Cello pegshapers can also be optionally fastened to the workbench using the base plate.

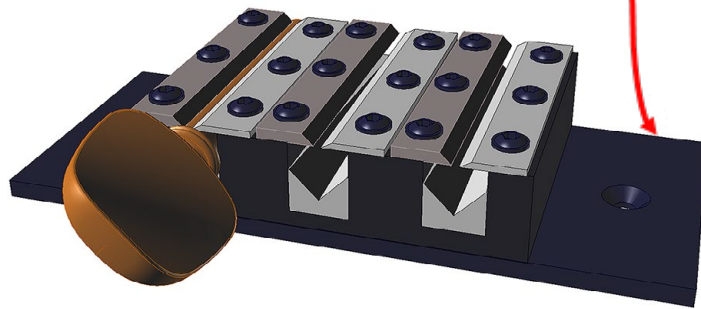

NEW CONCEPT PEG SHAPER

NO.	DESCRIPTION	\$\$-NET
CT-833.315	New Concept Violin Peg shaper - Small	166.88
CT-833.316	New Concept Violin Peg shaper - Regular	166.88
CT-833.425	New Concept Cello Peg shaper - Large	189.28
CT-833.426	New Concept Cello Peg shaper - Small	189.28

CT-833.315

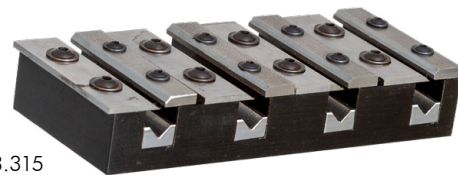

CT-833.425



BASE PLATE FOR NEW CONCEPT PEG SHAPER

NO.	DESCRIPTION	\$\$-NET
CT-833.317	Base plate for New Concept violin shaper	15.57
CT-833.427	Base plate for New Concept cello shaper	15.57



CT-833.317

TOOLS



REAMERS - CELLO ENDPIN REAMERS

Any instrument, whether it is a student or professional instrument, must be setup with an endpin that is precisely seated. The best tools for this job are CORE endpin reamers. These reamers come in a broad variety in our inventory, ranging from single-purpose tools for fitting brand-new cellos and basses to universal tools for fitting both cello and bass endpins. This powerful tool can repair an endpin in an antique bass with a diameter of up to 46 mm without the need to bush the hole.

CORE® Endpin Reamers come in variations of cutting edge: straight or spiral-shaped, and in two surface treatment variations - with or without TiN coating.



CT-833.935



CT-833.925



CT-833.915



CT-833.905

ENDPIN REAMERS - CELLO

HSS, 63 HRC.

NO.	DESCRIPTION	\$-NET
CT-833.935	Endpin Reamer Cello Taper 1:17 27.5/15.0mm Length 212.5mm Spiral Tin Coated	417.62
CT-833.925	Endpin Reamer Cello Taper 1:17 27.5/15.0mm Length 212.5mm Spiral Uncoated	271.58
CT-833.915	Endpin Reamer Cello Taper 1:17 27.5/15.0mm Length 212.5mm Straight Tin Coated	293.91
CT-833.905	Endpin Reamer Cello Taper 1:17 27.5/15.0mm Length 212.5mm Straight Uncoated	340.00
CT-833.907	Endpin Reamer Cello/Bass Taper 1:17 39/20mm Length 323mm Straight Uncoated	867.85

**PLEASE INQUIRE ABOUT
QUANTITY DISCOUNTS**



REAMERS - CELLO & BASS ENDPIN REAMERS

The CORE® collection provides a diverse array of endpin reamers. These range from slender options designed for fitting new cellos and basses, to a versatile tool suitable for both cello and double bass endpins. Additionally, there's a robust tool capable of refitting an endpin in an old bass with a diameter of up to 46 mm, eliminating the need for bushing the hole.



CT-833.926



CT-833.936



CT-833.906



CT-833.907

ENDPIN REAMERS - BASS

NO.	DESCRIPTION	\$-NET
CT-833.926	Endpin Reamer Bass Over Sized Taper 1:17 46/33.0mm Length 221mm Spiral Tin	1,023.10
CT-833.936	Endpin Reamer Bass Taper 1:17 36/23.0mm Length 221mm Spiral Tin	697.07
CT-833.906	Endpin Reamer Bass Taper 1:17 36/23.0mm Length 221mm Straight Uncoated	541.82
CT-833.907	Endpin Reamer Cello/Bass Taper 1:17 39/20mm Length 323mm Straight Uncoated	642.85

TOOLS



CLAMPS - ASSEMBLY GLUING CLAMP SETS

Our CORE® Violin Assembly Clamps Sets come with a few significant innovations and improvements.



CT-808.904

Two crucial aspects to consider during the assembly process, whether for a newly built violin or a repair, are precision and speed. **CORE® Assembly Clamps** excel in both areas. Speed is essential for maintaining the right gluing temperature, while precise function ensures the correct and safe distribution of gluing pressure.

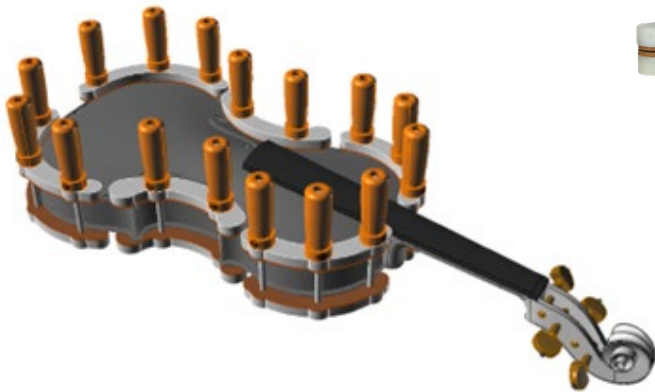

The central part of the set holds the corners and c-bouts together. This simplifies the most challenging part of the assembly, especially during violin repairs, as accurately positioning the corners is crucial for a proper assembly.

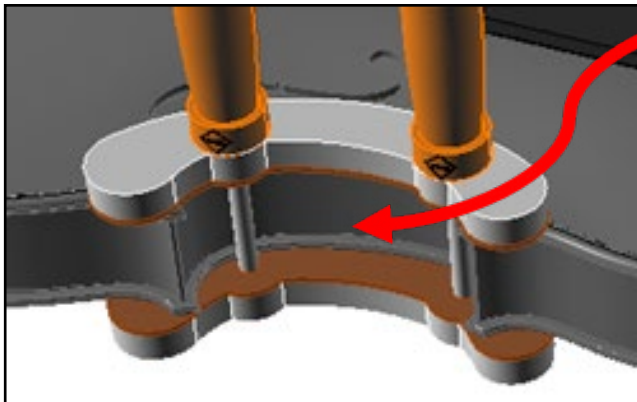

The sleek design of the jaws makes it accessible to reach the edge between the plate and ribs; thus, any spills and glue overflows can be easily removed.

The special feature is the double-helix thread on the rods, with a pitch of 0.08", which is twice as fast as a regular thread. This quickens the nut's action and allows the maker to finish the assembly while the glue is still hot, saving time.



The jaws are coated with a durable cork composition, and replacement pads are available as spare parts. These pads come pre-cut for swift and easy replacement. The jaws are CNC machined, and the holes on the movable jaws are drilled with precision, ensuring the movable jaw functions perfectly in parallel with the fixed one.

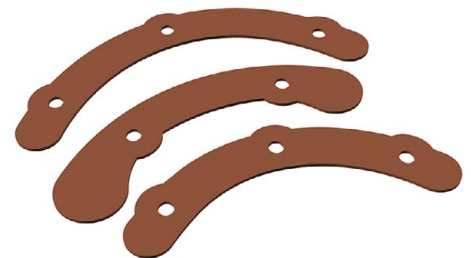

CLAMPS - ASSEMBLY GLUING CLAMP SETS

CORE® Cello Assembly Clamps Sets incorporate innovations similar to those in violin modification. These include a double-pitch thread for rapid assembly and a central component that aligns with corner sections for precise positioning.

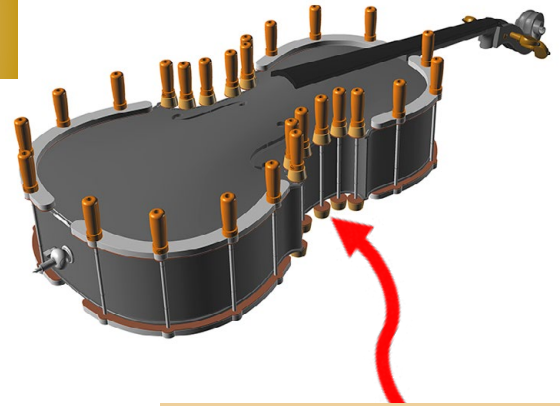
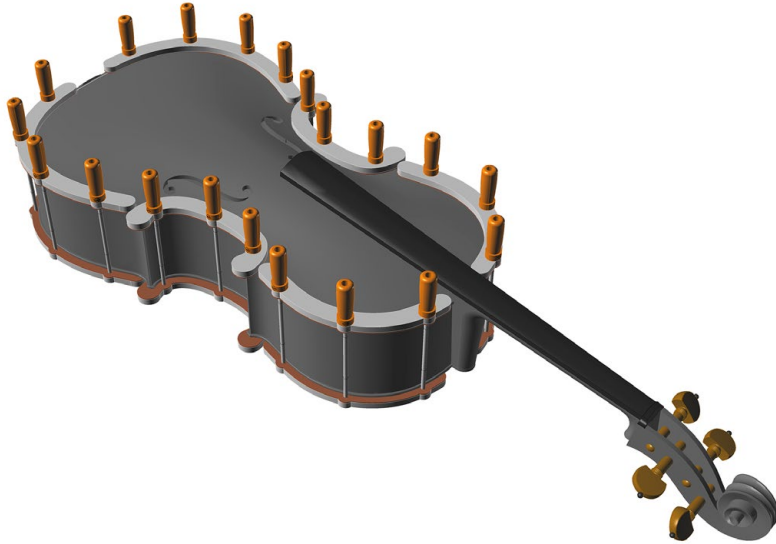

Cello patterns exhibit significantly more variability than violin patterns. The Assembly Clamps Set patterns are quite universal; however, there may still be cases where Single Assembly Clamps are required.



CT-808.905

NO.	DESCRIPTION	\$-NET
CT-808.904	Assembly glue clamp set, violin. 6 piece set. Polished maple handles, PA6 (nylon) jaws, padded with durable rubber-cork pads. Nickel plated rods, ¼" (6mm), double-pitch thread 0.08" (2mm). Opening 27-45 mm (1"-1¾")	246.85
CT-808.905	Assembly glue clamp set, cello. 6 piece set. Polished maple handles, PA6 (nylon) jaws, padded with durable rubber-cork pads. Nickel plated rods, ¼" (6mm), double-pitch thread 0.08" (2mm). Opening 110-145 mm (4 ¼" – 5 ¾")	340.00

TOOLS



CLAMPS - SINGLE ASSEMBLY GLUING CLAMPS

A fitting complement to the Assembly Clamp Sets!

Standard violin assembly clamp sets may not be fully compatible for assembling violas and fractional-sized violins. In such cases, single clamps are also necessary for the task.

CORE® Single Assembly Clamps are available in three sizes, violin, cello and double-bass



This clamp features a double-helix high-pitch thread of 0.08" and includes durable cork composition padding, which is also available as a spare part.

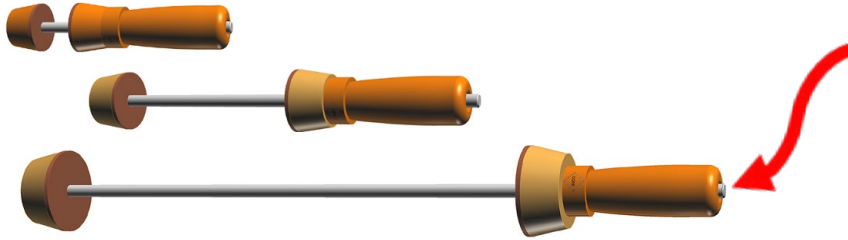

The double-bass Single Assembly Clamp is equipped with an 8mm rod featuring a trapezoidal thread with a pitch of 0.12". This configuration results in the CORE® Single Assembly Clamp having the fastest action speed among available options.



CT-838.846



CT-838.847



CT-838.848

NO.	DESCRIPTION	\$-NET
CT-838.848	Gluing Clamp Single, Maple Bass. Polished maple handles, and maple jaws, padded with durable rubber-cork pads. Nickel plated rods, 5/16" (8mm), trapezoidal thread pitch 0.1" (2mm). Opening 110-145 mm (4 1/4" – 5 3/4")	19.52
CT-838.847	Gluing Clamp Single, Maple Cello. Polished maple handles, and maple jaws, padded with durable rubber-cork pads. Nickel plated rods, 3/4" (6mm), double-pitch thread 0.08" (2mm). Opening 110-145 mm (4 1/4" – 5 3/4")	13.04
CT-838.846	Gluing Clamp Single, Maple Violin. Polished maple handles, and maple jaws, padded with durable rubber-cork pads. Nickel plated rods, 1/4" (6mm), double-pitch thread 0.08" (2mm). Opening 27-45 mm (1"-1 1/4")	11.26

RUBBER CORK PADS

NO.	DESCRIPTION	\$-NET
CT-838.867	Rubber Cork Pad Assemble Gluing Clamp Set Violin 12 Pcs	30.89
CT-838.868	Rubber Cork Pad Assemble Gluing Clamp Set Cello 12 Pcs	38.65
CT-838.869	Rubber Cork Pads For Gluing Clamps Violin 10 Pcs	9.17
CT-838.870	Rubber Cork Pads For Gluing Clamps Cello 10 Pcs	10.72
CT-838.871	Rubber Cork Pads For Gluing Clamps Bass 10 Pcs	10.72



TOOLS

CORE® "GUNTHER DICK" STYLE ASSEMBLY CLAMPS

High-quality PA6 (nylon) is meticulously used to craft generic replicas of the well-known clamps. These replicas feature color-differentiated jaws, making it easy to recognize their shape. They are also available in a cello version.

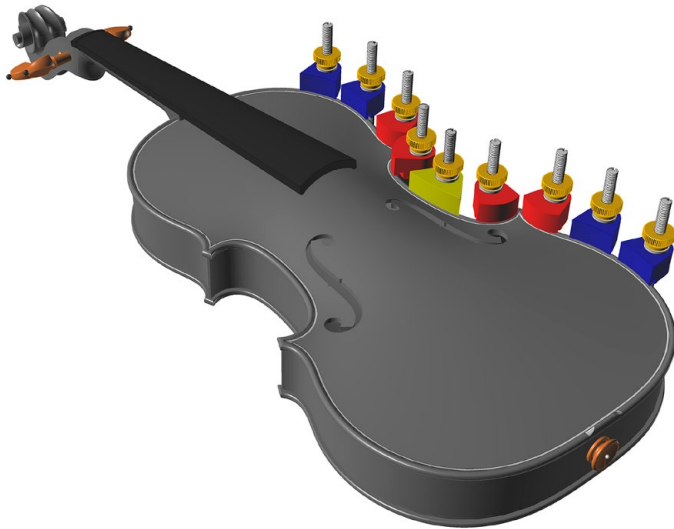

The "Gunther Dick" Assembly Clamps are ideal for repairing old instruments with worn and uneven plate and rib edges. Their shaped bodies ensure precise gluing pressure in specific areas. These clamps are also useful when regluing partly opened plates, allowing for precise pressure placement.



CT-838.805



CT-838.806



CT-838.807



CT-838.836



CT-838.835



CT-838.837

NO.	DESCRIPTION	\$-NET
VIOLIN		
Plastic PA 6 jaws (nylon) opening 0-2", blue jaws for outer bouts, yellow for C-bouts, red for corners. 0.25" rod, rifle finish, regular thread 0.25"		
CT-838.805	Assembly Clamp Violin, Blue	6.20
CT-838.806	Assembly Clamp Violin, Red	6.20
CT-838.807	Assembly Clamp Violin, Yellow	6.20
CELLO		
Plastic PA 6 jaws (nylon) opening 2" – 6", blue jaws for outer bouts, yellow for C-bouts, red for corners. 0.25" rod, rifle finish, regular thread 0.25"		
CT-838.835	Assembly Clamp Cello, Blue	8.90
CT-838.836	Assembly Clamp Cello, Red	8.90
CT-838.837	Assembly Clamp Cello, Yellow	8.90

PLEASE INQUIRE ABOUT
QUANTITY DISCOUNTS



CLAMPS - CRACK CLAMPS

CORE® Crack Clamps stand out as the market's most reliable and advanced designs. With these clamps, a luthier can repair a top crack without needing to open the instrument. These clamps can be easily shaped into the desired profile.

Top crack repair is a common procedure in the luthier's workshop. The most efficient approach involves using a clamp that applies the necessary gluing pressure precisely along the crack edges. The CORE® Repair Clamps are essential tools designed specifically for this purpose.

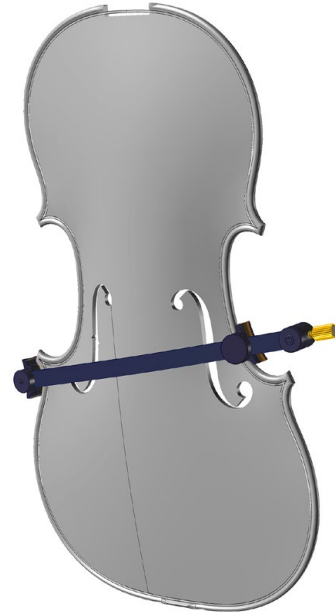
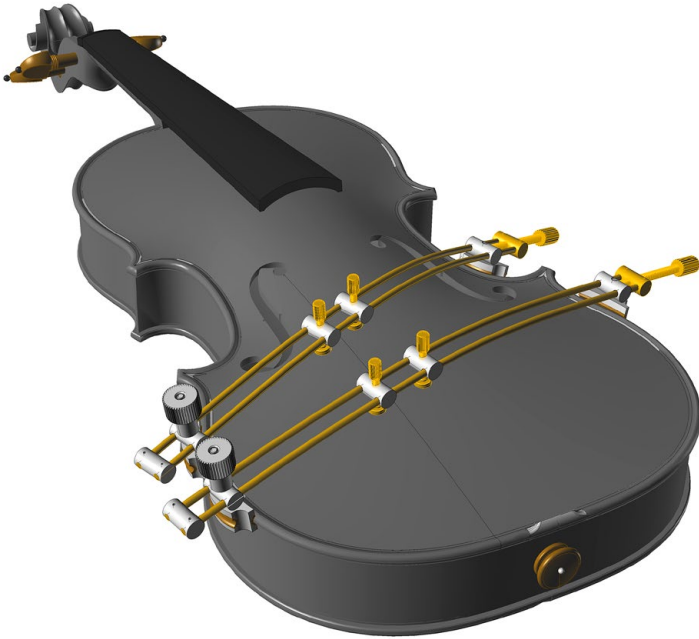

Both systems are equally applicable for crack repair. The double rod system offers enhanced versatility through its various configurations, while the aluminum flat-rod system is characterized by its lightweight construction and compatibility with other tools.

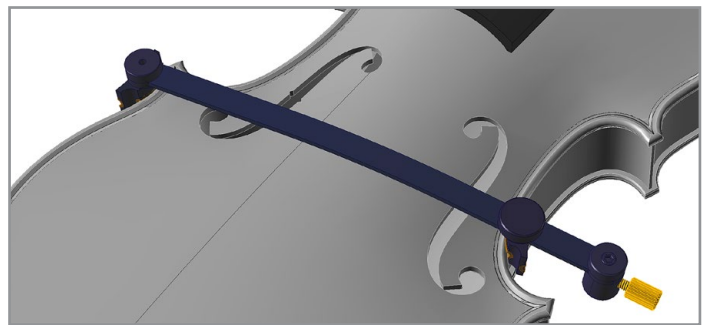

The CORE® Crack Clamps feature a distinctive jaw design, with radii that conform to the outlines of violins and cellos. Additionally, they have grooves designed to accommodate cork protectors. (Cut from self-adhesive cork sheets or straps, CORE items CT-838.863 and CT-838.864)

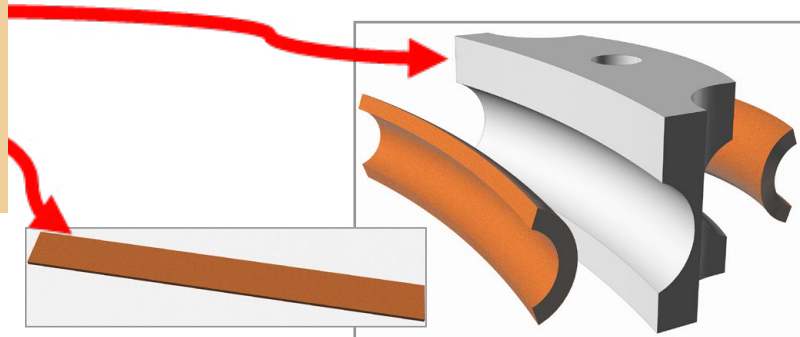

CLAMPS - CRACK CLAMPS

The double rod system is highly versatile, offering various clamp options for instruments such as the cello and double bass. These clamps come in different configurations, including those designed to fit into f-holes, clamps with side actions, and ones with three arms. This system's design allows for flexible adjustment of the jaw width across a range of lengths, and the positioning screws aid in aligning crack edges. (Additional cork pads are available for surface protection).

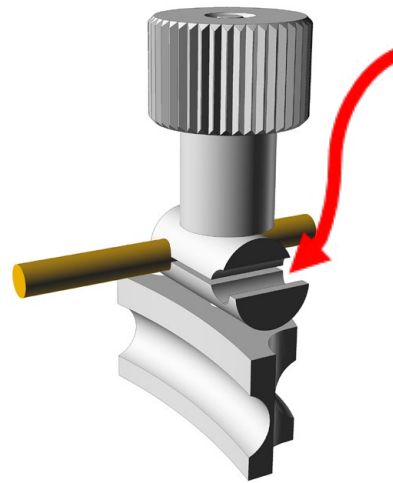

The distinctive feature of CORE® double rod Crack Clamps is the cleverly designed rear jaw locking system. In contrast to numerous imitations, the CORE® design enables smooth jaw rotation, guaranteeing a completely secure lock in its longitudinal position. Thanks to precision CNC machining, there's no requirement for manual adjustments, establishing these clamps as a leading choice in the market.

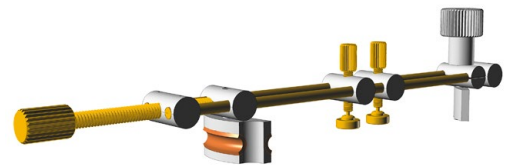
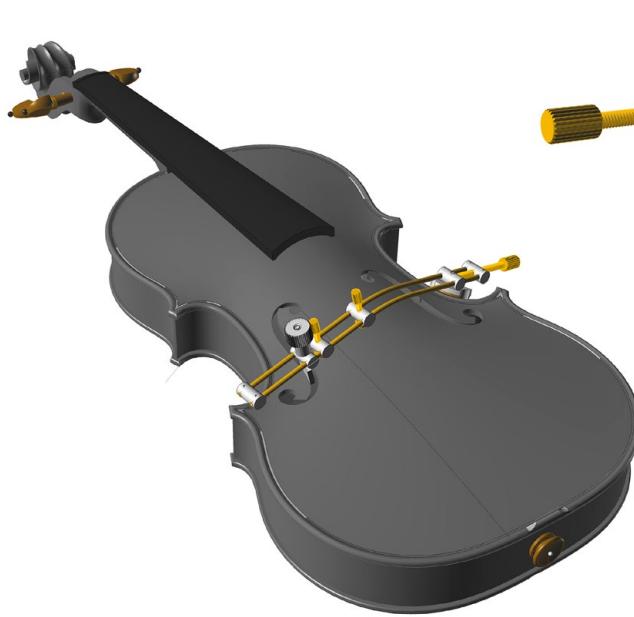
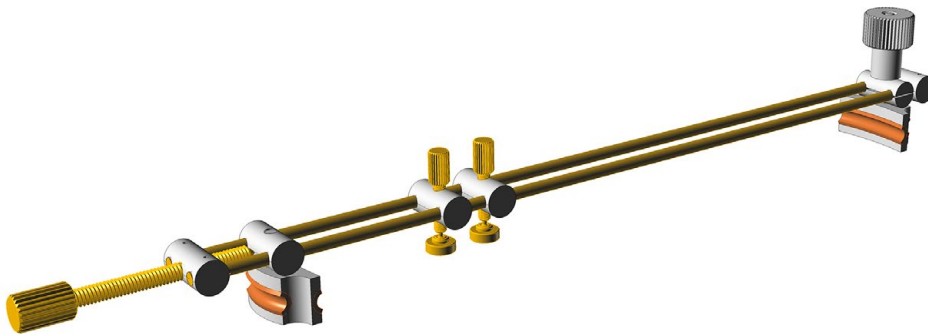

The double rod system offers impressive versatility with clamps designed for both cello and double bass, along with specialized clamps to fit within f-holes. The positioning screws are included to ensure a precise alignment of crack edges.

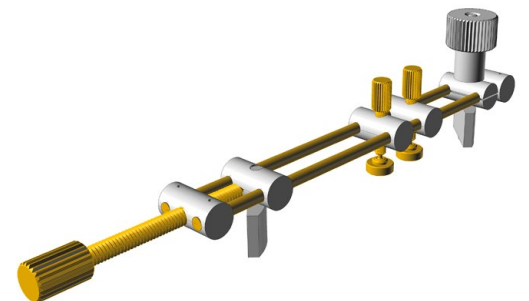

TOOLS



CLAMPS - CRACK CLAMPS

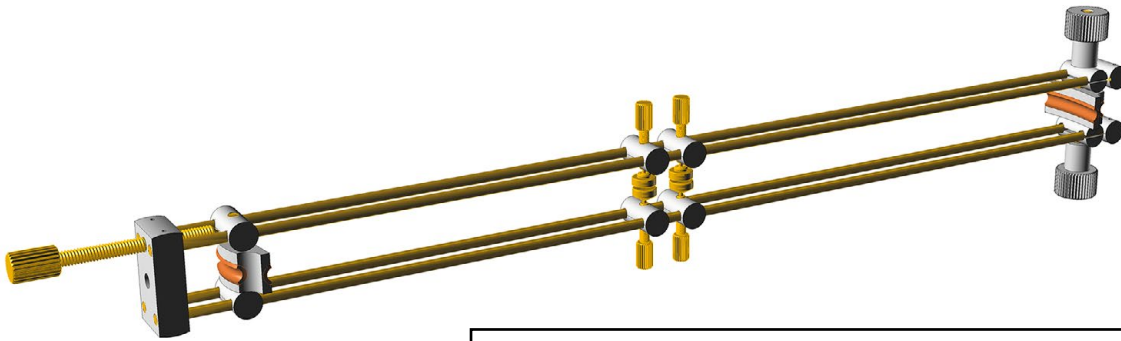

The design permits adjustment of the jaw width in a wide variety of lengths, Furthermore, the positioning screws serve to align the crack edges accurately.

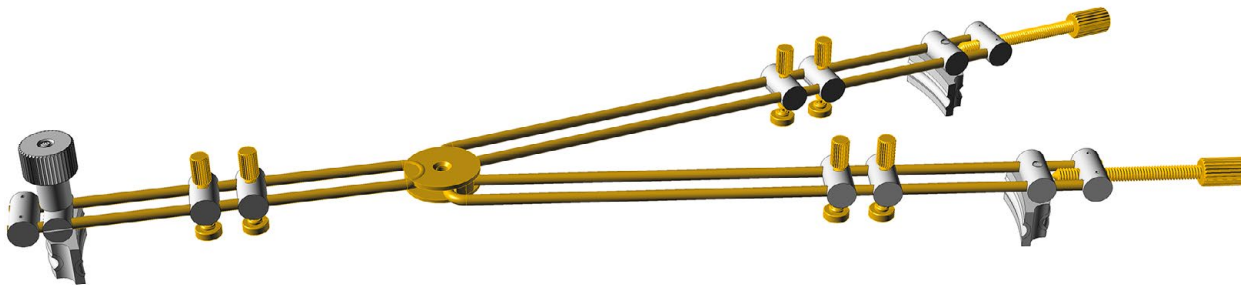

In contrast, the flat rod system maintains a fixed length. This requires the selection of an appropriately sized clamp for each dimension. The overlapping width spans ensure comprehensive coverage of all potential instrument dimensions. This system offers several key benefits, notably its minimal weight. For instance, violin set clamps weigh in at 12-18 grams. Additionally, it boasts a low clearance, which frees up space for the concurrent use of additional tools when securing the position of the crack edges.

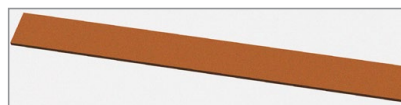
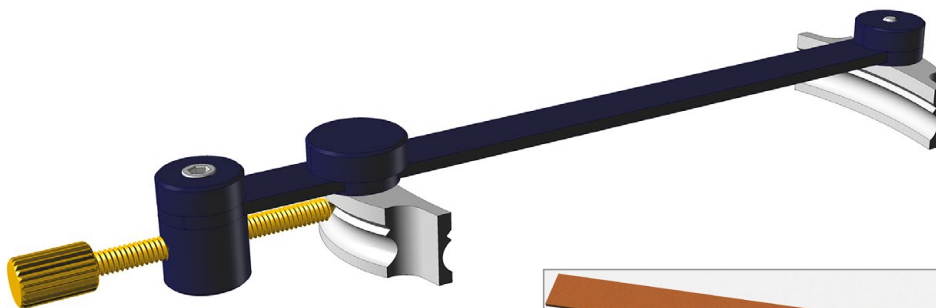

The jaws feature identical profiles, and there's also the option of using a cork sheet to soften the contact between the jaw and the instrument.



CLAMPS - CRACK CLAMPS

CRACK CLAMP TWO ROD SYSTEM

Crack clamps with adjustable jaw distance, maximum distance in the item description. Brass screws and rods, Aluminum jaws and moving parts, two positioning screws with swiveling pads.

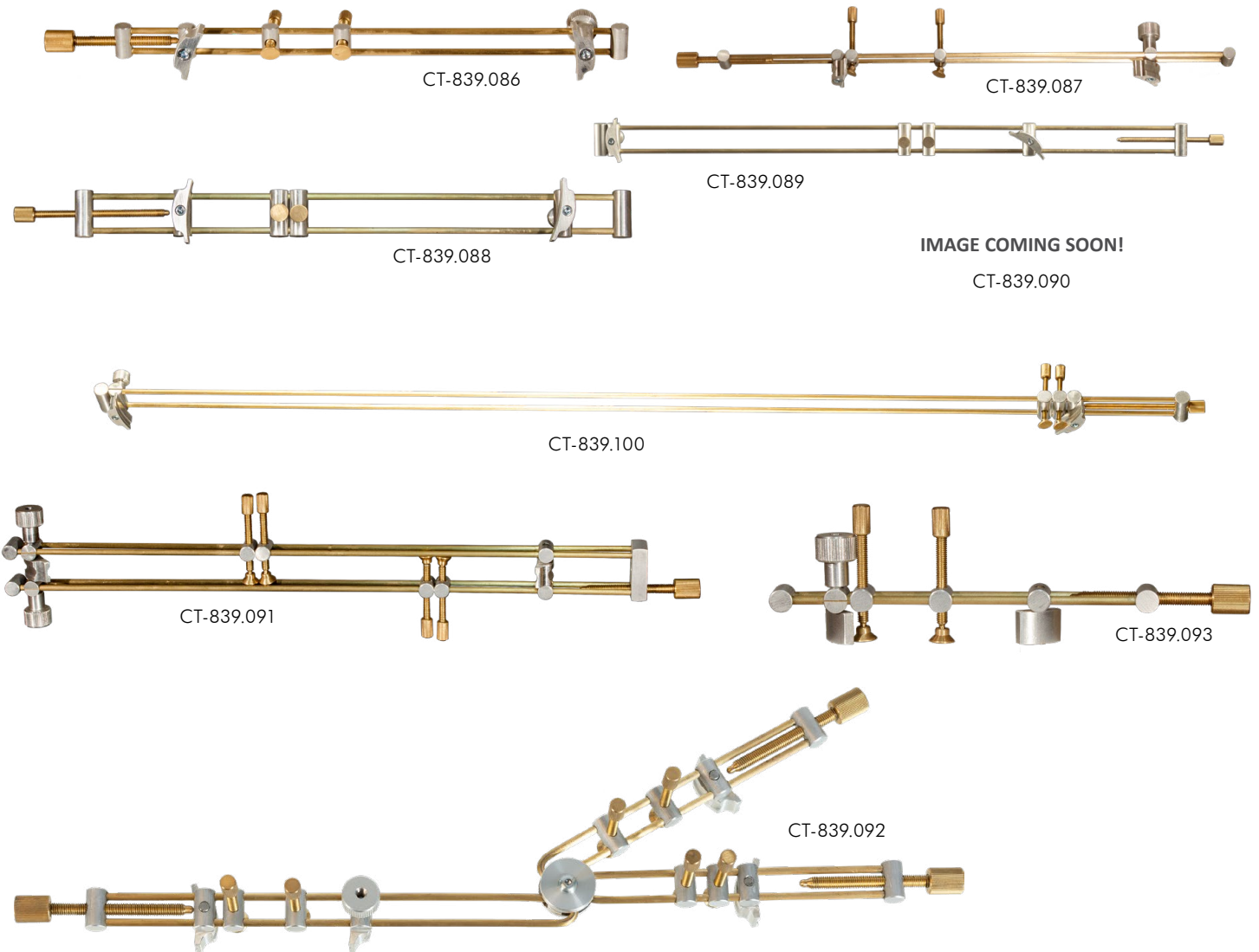

NO.	DESCRIPTION	\$-NET
CT-839.086	Crack Clamp Violin/Viola 180mm	53.76
CT-839.087	Crack Clamp Violin/Viola 280mm	53.76
CT-839.088	Crack Clamp Cello 300mm	64.96
CT-839.089	Crack Clamp Cello 500mm	64.96
CT-839.100	Crack Clamp Bass 800mm	64.96
CT-839.090	F-Hole Crack Clamp 155mm. The adjustable jaw is designed to fit into an f-hole. Specialized for repairs of cracks originating from f-hole. The maximum jaw distance is 150 mm. Brass screws and rods, Alu jaws and moving parts, two positioning screws with swiveling pads.	88.48
CT-839.091	Double sided repair clamp for violin, 280mm. The crack clamp is designed for use on detached plates. It features positioning screws on both surfaces of the plate to effectively align irregular or warped crack edges. Brass screws and rods, Aluminum jaws and moving parts, two positioning screws with swiveling pads.	95.20
CT-839.092	3-Arm crack Clamp Violin/Viola. The third arm helps to hold the clamp in position, where a straight clamp could not produce enough thrust or would simply slip off. Brass screws and rods, Aluminum jaws and moving parts, two positioning screws with swiveling pads.	98.56
CT-839.093	F-Hole crack clamp, 100mm. Both jaws can be inserted into f-holes. Specialized for repairs of cracks originating from f-hole, opened seams, soundpost cracks etc. Brass screws and rods, Aluminum jaws and moving parts, two positioning screws with swiveling pads.	53.76

TOOLS



CLAMPS - ALUMINUM CRACK CLAMPS



CT-839.034



CT-839.036



CT-839.035



CT-839.037



CT-839.039



CT-839.040



CT-839.041



CT-839.042

ALUMINUM CRACK CLAMPS

- Flat-rod crack clamp with extra low-weight design
- High-grade aluminium construction
- swiveling jaws
- brass thrust screw

NO.	DESCRIPTION	\$-NET
CT-839.039	Aluminum clamp cello 270-330 mm	59.36
CT-839.040	Aluminum clamp cello 320-380 mm	59.36
CT-839.041	Aluminum clamp cello 370-430 mm	59.36
CT-839.042	Aluminum clamp cello 420-480 mm	59.36
CT-839.034	Aluminum clamp violin/viola 110-150 mm	54.88
CT-839.035	Aluminum clamp violin/viola 145-185 mm	54.88
CT-839.036	Aluminum clamp violin/viola 180-220 mm	54.88
CT-839.037	Aluminum clamp violin/viola 215-255 mm	54.88

TOOLS



CLAMPS - LINING CLAMPS

Single-purpose clamps for gluing violin and cello linings.

CORE® Lining Clamps offer both excellent functionality and affordability. To glue one side of a violin rib-cage, you typically require a set of 40 to 50 pieces. For cellos, a larger quantity of 100-120 pieces is needed.

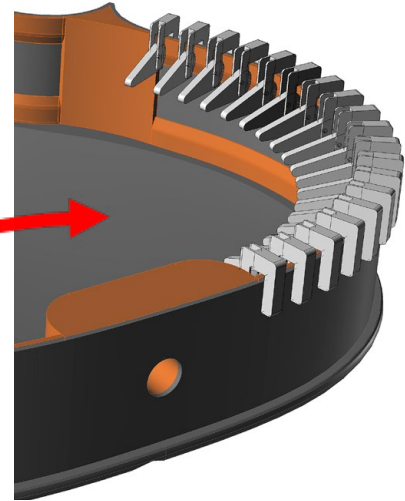
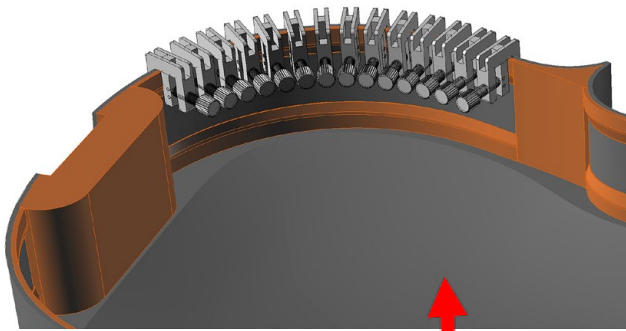

Gluing the lining requires quick action, with about 20 clamps needed to keep the glue adequately warm during the gluing of one bout. The lever fastening system streamlines this process. To achieve the best results, it's recommended to first secure the lining's position using screw fastening and then quickly attach a set of lever clamps.

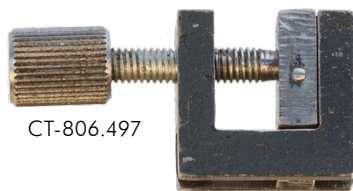

CT-806.497

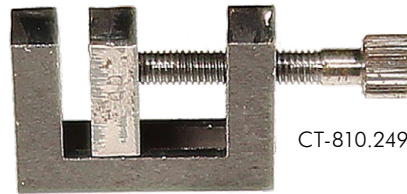

CT-810.249



CT-839.005



CT-838.503

NO.	DESCRIPTION	\$-NET
CT-806.497	Lining Clamp Violin Screw Type. Steel clamp with screw action, violin opening 4.1-2.4 mm.	7.84
CT-810.249	Lining Clamp Cello Screw Type. Steel clamp with screw action, cello opening 5.6-4.0 mm	11.76
CT-839.005	Lining Clamp Violin Lever Type. Steel clamp with lever action, violin opening 4.1-2.4 mm.	8.96
CT-838.503	Lining Clamp Cello Lever Type. Steel clamp with lever action, cello opening 5.6-4.0 mm.	13.44

**PLEASE INQUIRE ABOUT
QUANTITY DISCOUNTS**



CLAMPS - REPAIR CLAMPS

Our **CORE® Repair Clamps** are versatile and can be used in various applications within a luthier's shop. They are lightweight, perfectly horizontal, and have a smooth action-tightening screw.



All CORE® Repair Clamps feature lightweight, optimized construction. The wider shoulder provides enhanced stiffness, and the elliptical cutouts reduce weight by almost 40% compared to a full-bodied design, all while maintaining stiffness.

This tool features a brass screw that ensures a smooth tightening process. It also has a ball end that allows the pad to swivel freely. You can adjust the lower pad's position within a 5 mm range, and both pads can be covered with self-adhesive cork pads when necessary.

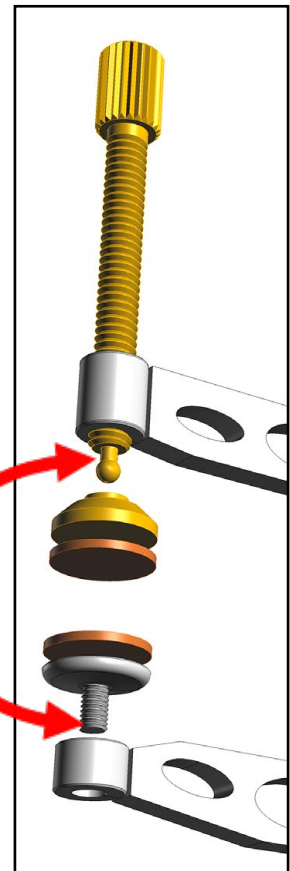

The CORE® Tools assortment caters to all the details and needs that a luthier encounters in their daily work. The **SELF-ADHESIVE CORK PADS** are constructed from a durable rubber-cork composition and are coated with a 3M adhesive layer on one side. These pads can be affixed to the clamps' pads when protecting delicate surfaces is necessary. They are available in a variety of diameters to suit your requirements.



CLAMPS - REPAIR CLAMPS

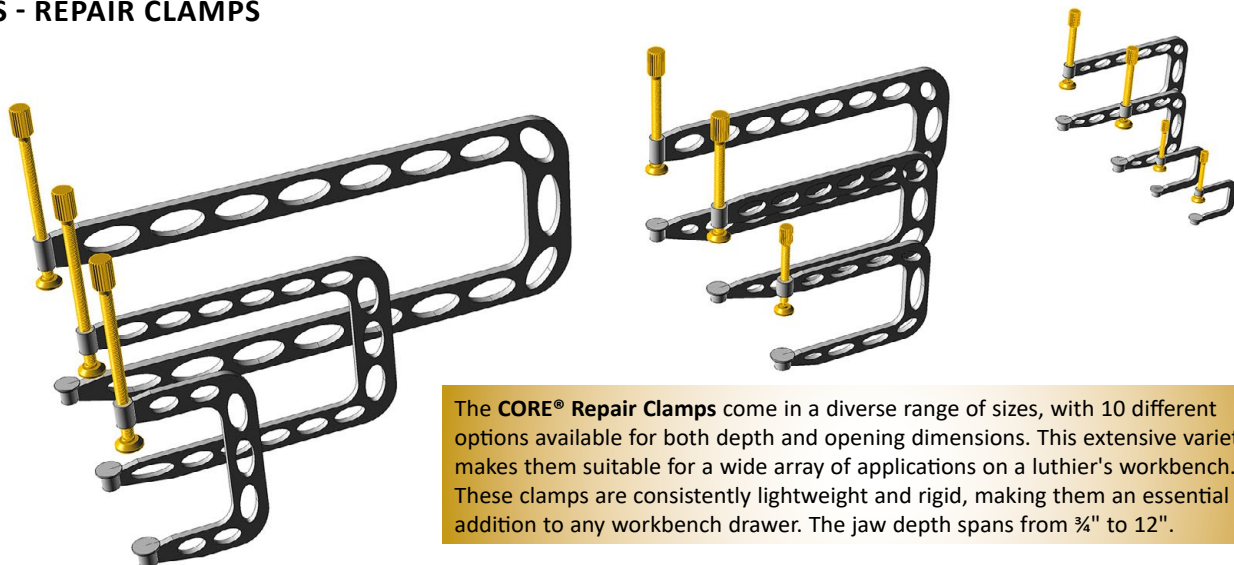

The CORE® Repair Clamps come in a diverse range of sizes, with 10 different options available for both depth and opening dimensions. This extensive variety makes them suitable for a wide array of applications on a luthier's workbench. These clamps are consistently lightweight and rigid, making them an essential addition to any workbench drawer. The jaw depth spans from ¾" to 12".

Our CORE® Repair Clamps Over the Ribs are a special design derived from the general-purpose repair clamps. These clamps enable working on the belly of a cello or double bass, without disconnecting the ribs.

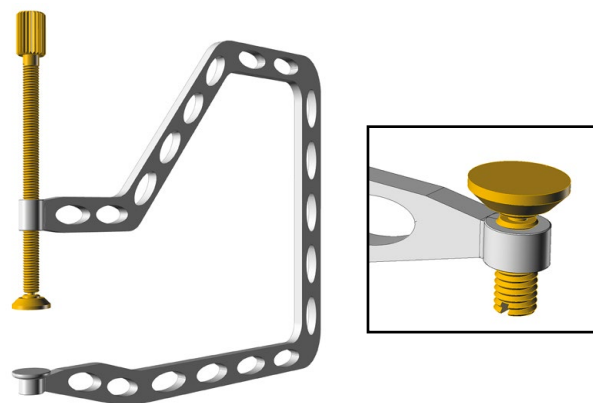
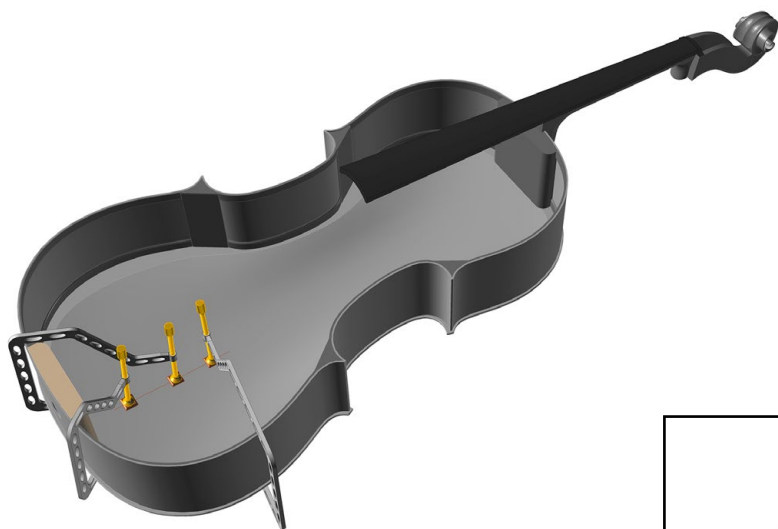

The design of CORE® Over the Ribs Clamps is tailored specifically for their intended purpose. They feature a 13½" clearance to accommodate the rib height and have a 2" opening to ensure stable clamping. Additionally, the lower pad can be replaced with a swivel pad if desired. These clamps are available in three depths and also come in a double bass version.

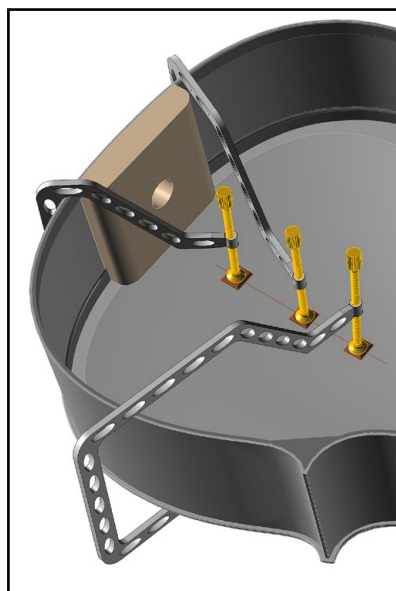

Every luthier would prefer to avoid the task of disconnecting the ribs from the belly. These clamps simplify tasks like placing and gluing cleats, patching soundpost cracks, and other repairs on the belly while keeping the ribs attached.



TOOLS



CLAMPS - REPAIR CLAMPS



REPAIR CLAMPS

Steel body, brass thrust screw, swiveling brass pad. Dimensions: depth/ opening.

NO.	DESCRIPTION	\$-NET
CT-838.924	Repair clamp 26/10mm	22.29
CT-838.925	Repair clamp 29/15mm	25.20
CT-838.926	Repair clamp 40/30mm	29.12
CT-838.927	Repair clamp 90/28mm	30.24
CT-838.928	Repair clamp 85/37mm	32.48
CT-838.929	Repair clamp 135/40mm	33.49
CT-838.930	Repair clamp 200/40mm	39.20
CT-838.931	Repair clamp 50/75mm	33.49
CT-838.932	Repair clamp 150/75mm	43.68
CT-838.933	Repair clamp 300/75mm	54.88

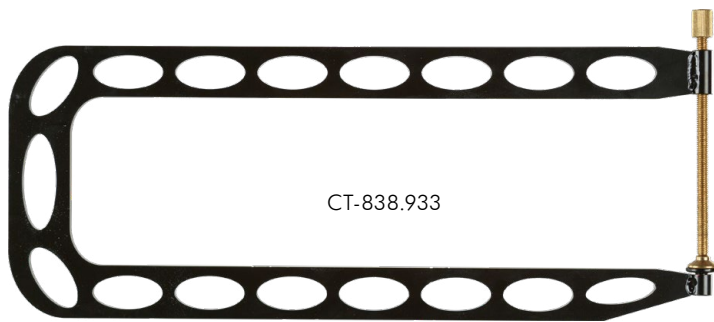

SELF-ADHESIVE RUBBERCORK PADS

Self-adhesive 10-piece packs.

NO.	DESCRIPTION	\$-NET
CT-838.855	Rubbercork pad 5mm	3.25
CT-838.856	Rubbercork pad 6mm	3.25
CT-838.858	Rubbercork pad 7mm	3.81
CT-838.859	Rubbercork pad 8mm	3.25
CT-838.857	Rubbercork pad 9mm	3.81
CT-838.860	Rubbercork pad 12mm	3.81
CT-838.861	Rubbercork pad 15mm	3.81
CT-838.862	Rubbercork pad 6x100	3.25
CT-838.863	Rubbercork pad 10x100	3.25
CT-838.864	Rubbercork pad 50x100	4.37

TOOLS



CLAMPS - REPAIR CLAMPS, OVER THE RIBS

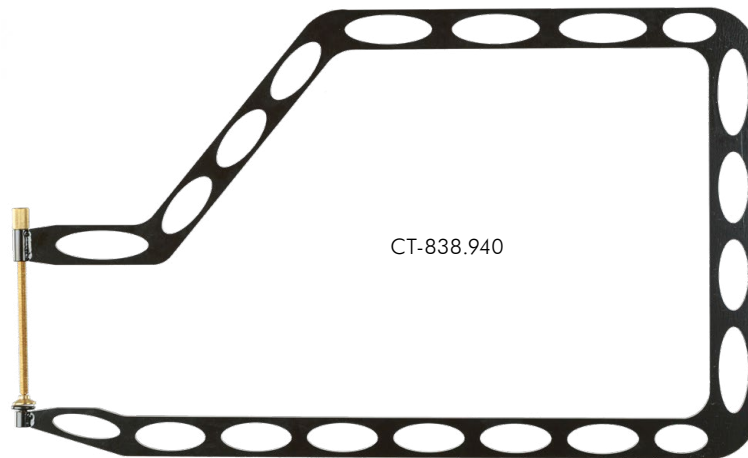
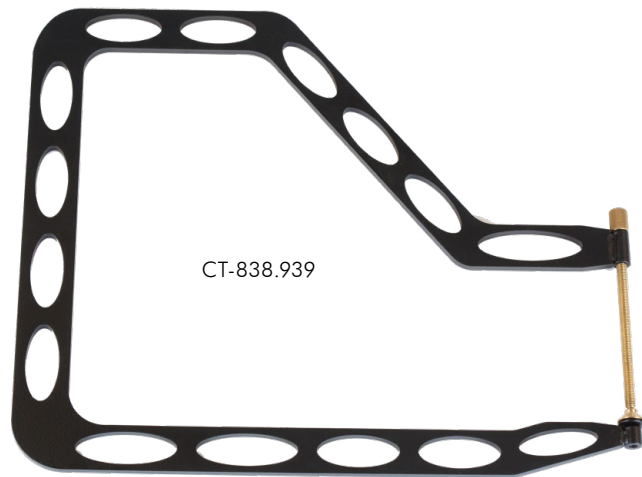
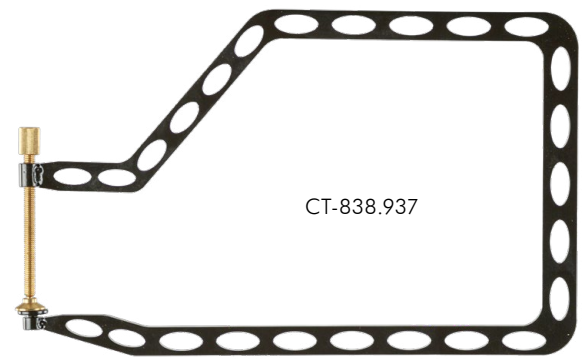

REPAIR CLAMPS - OVER THE RIBS

Steel body, brass thrust screw, swiveling brass pad. Opening 2", jaw depth in the item description

NO.	DESCRIPTION	\$-NET
CT-838.935	Repair Clamp Over The Ribs Cello 122 mm	50.40
CT-838.936	Repair Clamp Over The Ribs Cello 175 mm	50.40
CT-838.937	Repair Clamp Over The Ribs Cello 244 mm	50.40
CT-838.938	Repair Clamp Over The Ribs Bass 210 mm	66.08
CT-838.939	Repair Clamp Over The Ribs Bass 300 mm	66.08
CT-838.940	Repair Clamp Over The Ribs Bass 420 mm	72.80

TOOLS



CLAMPS - SPECIAL CRACK CLAMPS

Our CORE® **Special Crack Clamps** are the preferred choice of luthiers when conducting extensive repairs, specifically addressing detached plates. In situations where the structural integrity of the plate cannot withstand the pressure exerted along its edges, it becomes imperative to employ more specialized clamps.

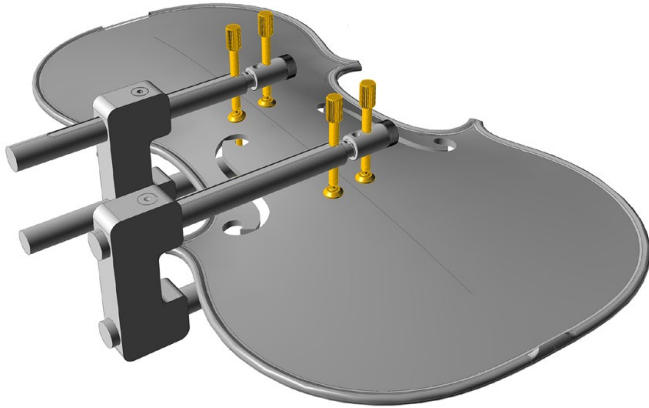

C-SHAPE REPAIR CLAMP

The CORE® C-shape Clamp is a versatile tool designed for fixing cracks in violin and viola plates. It focuses adhesive pressure on the crack area and can be adjusted for various setups, allowing multiple clamps to be used together for comprehensive repairs.

NO.	DESCRIPTION	\$-NET
CT-839.055	C-Shape Repair Clamp	95.20



CT-839.055

The genuine game-changing feature in CORE® Tools' special crack clamps is the C-Clamp. The fundamental operating principle lies in the movable outer segment of the arm, which can be adjusted toward the stationary end by means of the knurled nut. The securing screws facilitate precise alignment of the crack's edges to achieve an ideal flush position. The adjustable depth capability renders this clamp a versatile, one-size-fits-all tool.

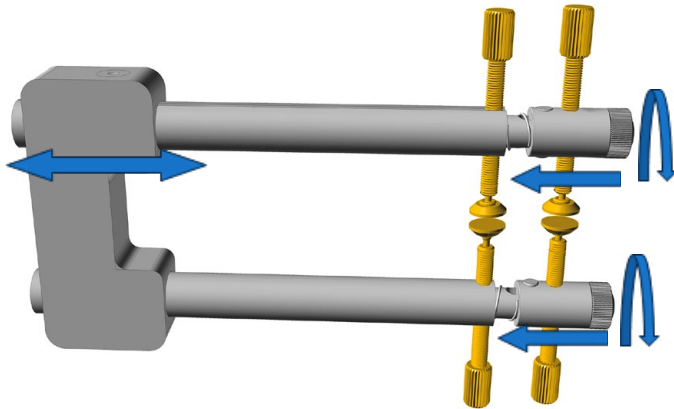

When dealing with a cello top, a different approach is required. Attempting to create a C-clamp-like tool for cellos resulted in a heavy and unwieldy design. Instead, a mini parallel clamp, applied to preinstalled wooden cleats, serves a similar purpose. By adjusting the jaw angle, this clamp effectively aligns the crack edges.

MINI PARALLEL CLAMP

The CORE® Mini Parallel Clamp is a versatile tool with adjustable jaws for various clamping methods. Weighing approximately 13 grams, it's safe for delicate structures like a cello top, offering both parallel and angled clamping options.

NO.	DESCRIPTION	\$-NET
CT-808.927	Mini Parallel Clamp. Steel construction, jaw depth 22m , maximum opening 55mm.	54.88

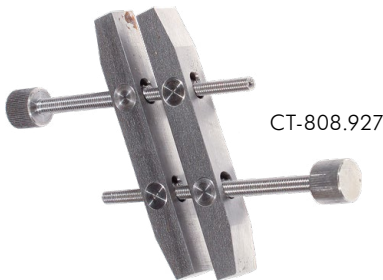

CT-808.927

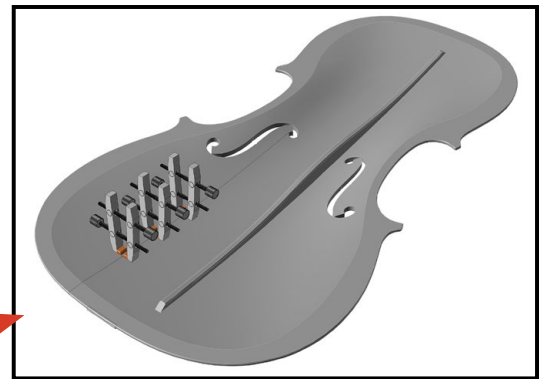

Repairing an antique instrument requires creativity and the right tools. CORE® crack clamps offer flexibility, allowing you to combine them in different ways to achieve the perfect outcome, similar to having a versatile toolbox at your disposal.

TOOLS



CLAMPS - SPECIAL CRACK CLAMPS

EDGE CLAMP

NO.	DESCRIPTION	\$-NET
CT-809.056	Edge clamp. Aluminum construction, brass screws and pads. . Max. opening 6mm.	133.28

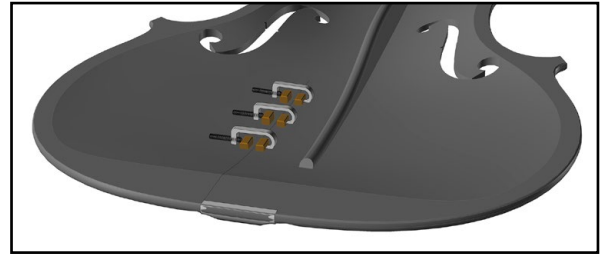

CT-809.056



CT-809.138

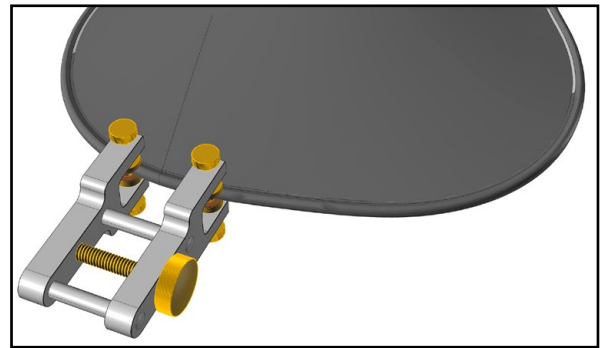

MICRO CRACK CLAMP

The CORE® Micro Clamp, weighing only about 5 grams, offers a solution for carefully repairing the top plate of an antique violin using traditional methods. (Allen key not included.)

NO.	DESCRIPTION	\$-NET
CT-809.138	Micro Crack Clamp. Weight 5gr, opening 13mm. Steel construction.	7.73

CLAMPS - LIGHTWEIGHT ALUMINUM CLAMPS

LIGHTWEIGHT ALUMINUM CLAMPS

Weight is a critical factor when mending a detached top plate or fixing a rib crack on violins, violas, or cellos. Our aluminum lightweight clamps strike a balance, being both light and suitably rigid. This is achieved through the arm's design and the rounded shoulder pattern. Additionally, self-adhesive cork pads are provided to safeguard delicate surfaces during the repair process.

NO.	DESCRIPTION	\$-NET
CT-809.094	Aluminum Repair Clamp Jaw Depth/Extension: 85 mm, Jaw Opening: 35 mm	24.03
CT-809.095	Aluminum Repair Clamp Jaw Depth/Extension: 120 mm, Jaw Opening: 35 mm	25.30
CT-809.096	Aluminum Repair Clamp Jaw Depth/Extension: 160 mm, Jaw opening: 40 mm	30.36
CT-809.097	Aluminum Repair Clamp Jaw Depth/Extension: 200 mm, Jaw opening: 50 mm	32.89



CT-809.094



CT-809.095



CT-809.096



CT-809.097

TOOLS



SOUNDPOST INSTALLATION TOOLS



SOUNDPOST SETTERS

NO.	DESCRIPTION	\$-NET
CT-803.322	Soundpost Setter Duo Violin/Viola	11.09
CT-803.323	Soundpost Setter Duo Cello	22.29
CT-803.324	Soundpost Setter Duo Bass	32.48
CT-803.326	Soundpost Setter Forte Violin/Viola	13.33
CT-803.327	Soundpost Setter Forte Cello	22.29
CT-803.328	Soundpost Setter Forte Bass	32.48

TOOLS

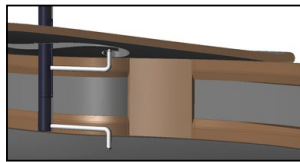

F-HOLE FLAP LIFTERS & INSIDE CALIPERS

Inside calipers are an excellent tool for soundpost installation. By using these, one can significantly reduce the number of failed attempts when installing the soundpost. Repairing might be difficult at times and the most difficult aspect of this technique is leveling both sides of the crack. This operation is made easier by the CORE f-flap lifter.

NO.	DESCRIPTION	\$-NET
CT-806.407	F-Hole Flap Lifter, Violin/Viola	24.84
CT-806.408	F-Hole Flap Lifter, Cello	35.71
CT-806.409	F-Hole Flap Lifter, Bass	49.68
CT-803.315	Inside Caliper, Violin/ Viola	34.16
CT-803.316	Inside Caliper, Cello	45.02



STRING LIFTERS

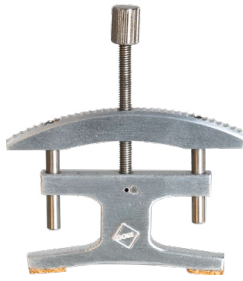

CT-842.705



CT-842.706



CT-842.707

NO.	DESCRIPTION	\$-NET
CT-842.705	String Lifter Violin	66.08
CT-842.706	String Lifter Cello	84.00
CT-842.707	String Lifter Bass	110.88

DRILLING JIGS



CT-833.321



CT-833.322

NO.	DESCRIPTION	\$-NET
CT-833.321	Drilling Jig for Violin Pegs	21.28
CT-833.322	Drilling Jig for Cello Pegs	24.64

BRIDGE LEG EXPANDER

IMAGE COMING SOON!

NO.	DESCRIPTION	\$-NET
CT-810.104	Bridge Leg Expander	21.74

FINGERBOARD PADS



CT-810.104

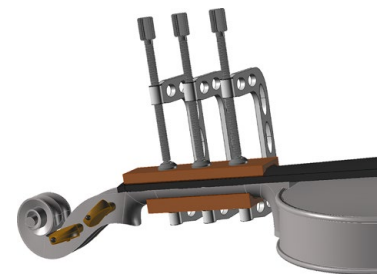

NO.	DESCRIPTION	\$-NET
CT-839.014	Fingerboard Pads Violin, Ash	15.38
CT-839.015	Fingerboard Pads Cello, Ash	24.69

DIGITAL CALIPER

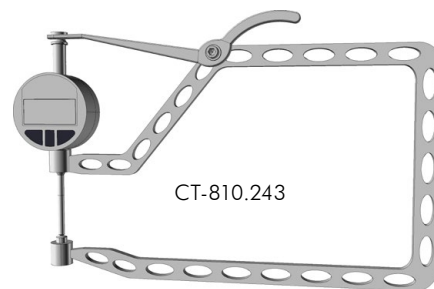

CT-810.243

NO.	DESCRIPTION	\$-NET
CT-810.243	Digital Caliper	278.88

TOOLS



KNIVES

The CORE® collection of knives and blades features two distinct types of tools:

1. Western Style:

Crafted from solid steel, specifically the genuine "VOEST STABIL," advanced tool steel produced in Austria with a carefully proven hardening treatment refined over the years. Hardened to HRC 62-63, the cutting edge of these blades can be easily sharpened to achieve long-lasting sharpness. The steel formula includes Wolfram for enhanced durability. Overall, these blades embody the best European tool-making tradition and are available as bare blades or inserted into an ashwood handle. The most extensive modification is traditionally carved with a single-side bevel.

2. Japanese Blades:

These blades have gained fame over the last 50 years in the global market. They are crafted traditionally using 2-layered steel, connecting a tough cutting-edge layer with a milder core. This construction facilitates grinding and honing. The carving of these blades is traditionally one-sided, and they are available in both left and right bevel modifications. Sets of MIKISHA blades and KURI blades are inserted into an ashwood handle.



CT-750.040



CT-750.050



CT-750.041



CT-750.051

NO.	DESCRIPTION	\$-NET
CT-750.040	TK066/Kuri Knife Right bevel	30.13
CT-750.041	TK999/Kuri Knife Left Bevel	33.49
CT-750.050	TK063/Yoko Knife Right Bevel	30.13
CT-750.051	TK999/Yoko Knife Left Bevel	33.49

MIKISHA JAPANESE CARVING KNIVES

NO.	DESCRIPTION	\$-NET
CT-750.030	Mikikichan Japanese Knives 6pcs	166.88



CT-750.030



KNIVES



CT-813.574



CT-813.577



CT-813.578



CT-813.579

NO.	DESCRIPTION	\$-NET
CT-813.574	Knife 6 mm Both Side Bevel, With Handle	32.48
CT-813.575	Knife 8 mm Both Side Bevel, With Handle	32.48
CT-813.576	Knife 10 mm Both Side Bevel, With Handle	32.48
CT-813.577	Knife 12 mm Both Side Bevel, With Handle	32.48
CT-813.578	Knife 16 mm Right Bevel, With Handle	32.48
CT-813.579	Knife 16 mm Left Bevel, With Handle	32.48
CT-813.580	Knife Blade 6 mm Both Side Bevel	11.33
CT-813.581	Knife Blade 8 mm Both Side Bevel	11.33
CT-813.582	Knife Blade 10 mm Both Side Bevel	13.08
CT-813.583	Knife Blade 12 mm Both Side Bevel	13.08
CT-813.584	Knife Blade 16 mm Right Bevel	11.14
CT-813.585	Knife Blade 16 mm Left Bevel	11.14



CT-813.580



CT-813.582



CT-813.583



CT-813.584



CT-813.585

MIKIHISA JAPANESE CARVING KNIVES

NO.	DESCRIPTION	\$-NET
CT-750.004	Mikihisa Japanese Carving Knife 6mm, Right Bevel, Hammered eyes finish. No Handle.	22.29
CT-750.005	Mikihisa Japanese Carving Knife 9mm, Right Bevel, Hammered eyes finish. No Handle.	22.29
CT-750.006	Mikihisa Japanese Carving Knife 12mm, Right Bevel, Hammered eyes finish. No Handle.	22.29
CT-750.007	Mikihisa Japanese Carving Knife 18mm, Right Bevel, Hammered eyes finish. No Handle.	24.53
CT-750.008	Mikihisa Japanese Carving Knife 6mm Left Bevel, Hammered eyes finish. No Handle.	24.53
CT-750.009	Mikihisa Japanese Carving Knife 9mm Left Bevel, Hammered eyes finish. No Handle.	24.53
CT-750.010	Mikihisa Japanese Carving Knife 12mm Left Bevel, Hammered eyes finish. No Handle.	24.53
CT-750.011	Mikihisa Japanese Carving Knife 18mm Left Bevel, Hammered eyes finish. No Handle.	26.77



CT-750.004



CT-750.008



CT-750.005



CT-750.009



CT-750.006



CT-750.010



CT-750.007



CT-750.011



SCRAPERS

IMAGE COMING SOON!

CT-806.741



CT-806.742



CT-806.743



CT-806.744



CT-806.745



CT-806.746



CT-833.704

IMAGE COMING SOON!

CT-833.705



CT-833.714

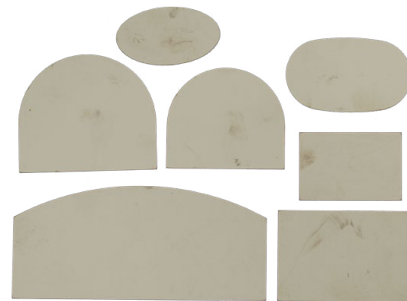

CT-833.720



CT-833.721



CT-833.739

Within the CORE® selection of scrapers, you'll find two distinct types, each available in a variety of shapes. The traditional **carbon steel** scrapers are crafted from hot rolled steel, a process that imparts a more uniform material structure throughout the thickness. This choice of material enhances the durability of CORE scrapers when compared to those made from cold-rolled steel. Cold rolling, in contrast, leaves the surface layers significantly harder than the volume inside the sheet.

In addition, the **stainless steel** scrapers represent a recent industry advancement. Despite their relatively softer edge compared to carbon steel, the stainless steel variety exhibits significantly greater resistance to wear, resulting in enhanced overall durability. Moreover, their rustproof nature makes these scrapers especially well-suited for specific tasks, such as removing glue from recently bonded surfaces, particularly on the neck and fingerboard, and cleaning the interior of instruments during repairs.

NO.	DESCRIPTION	\$-NET
CT-806.741	Scraper 0.30 Carbon Steel	4.80
CT-806.742	Scraper 0.40 Carbon Steel	5.17
CT-806.743	Scraper 0.80 Carbon Steel	9.73
CT-806.744	Scraper 0.25 Stainless Steel	4.80
CT-806.745	Scraper 0.40 Stainless Steel	5.17
CT-806.746	Scraper 0.80 Stainless Steel	9.73
CT-833.704	Scraper Gooseneck Carbon Steel 0.4 mm	12.20
CT-833.705	Scraper Gooseneck Stainless Steel 0.5 mm	6.04
CT-833.714	Scraper Set Stainless Steel 0.8 mm	30.78
CT-833.720	Scraper Set Stainless Steel 0.5 mm	26.75
CT-833.721	Scraper Set Carbon Steel 0.8 mm	30.78
CT-833.739	Scraper Set Carbon Steel 0.4 mm	26.75

TOOLS



GOUGES

The Western style gouges, constructed from solid steel, specifically the genuine "VOEST STABIL" from Austria, boast advanced tool steel. These gouges undergo a meticulous and proven hardening treatment, achieving a hardness of HRC 62-63 for the cutting edge. The inclusion of Wolfram in the steel formula enhances durability. Overall, these gouges embody the pinnacle of European tool-making tradition and come delivered with an ashwood handle. The blades feature slightly rounded (filleted) edges, facilitating a comfortable grip in the palm for delicate operations.

Japanese gouges have earned their fame over the last 50 years in the global market. The blades of these gouges are crafted in a traditional manner, using 2-layered steel that connects a very hard cutting edge layer with a milder core. This construction eases the processes of grinding and honing. Additionally, the back side of these gouges is traditionally slightly chamfered, further facilitating the grinding and honing processes.



CT-813.310

NO.	DESCRIPTION	\$-NET
CT-813.310	Flat Gouges Set 5 Piece	190.40

CHISELS



CT-755.001



CT-755.002



CT-755.003



CT-755.004



CT-755.005

NO.	DESCRIPTION	\$-NET
CT-755.001	Kinari Chisel 3mm	54.88
CT-755.002	Kinari Chisel 6mm	54.88
CT-755.003	Kinari Chisel 9mm	54.88
CT-755.004	Kinari Chisel 12mm	59.36
CT-755.005	Kinari Chisel 18mm	59.36

TOOLS



FILES & RASPS

HAND-CUT RASPS

CORE Hand-cut Rasps stand as a true masterpiece in European toolmaking. Hand cutting, unparalleled by any machine, ensures the distinctive irregularity of the cutting pattern, resulting in efficient material removal and a cut of superior finesse. This unique approach transforms the rasp into a tool that acts more like a file, maximizing efficiency. Crafted in Europe, these rasps embody the finest material grade and undergo meticulous heat treatment, guaranteeing exceptional quality.

Regarding the cut numbers: cut 1 is finest, cut 10 is coarsest.



CT-807.706

HAND-CUT RASPS - FLAT

NO.	DESCRIPTION	\$-NET
CT-807.706	Hand-cut rasp flat 125 mm, 10x5 cut 5	42.56
CT-807.709	Hand-cut rasp flat 200 mm, 25x5 cut 3	60.48
CT-807.710	Hand-cut rasp flat 200 mm, 25x5 cut 4	64.96
CT-807.711	Hand-cut rasp flat 200 mm, 25x5 cut 5	72.80
CT-807.908	Hand-cut rasp flat 150 mm, 16x4 cut 5	50.40
CT-807.911	Hand-cut rasp flat 200 mm, 20x5 cut 5	66.08
CT-807.913	Hand-cut rasp flat 200 mm, 20x5 cut 10	110.88



CT-807.936

HAND-CUT RASPS - HALFROUND

NO.	DESCRIPTION	\$-NET
CT-807.936	Hand-cut rasp halfround 150 mm, 16x6 cut 5	99.68
CT-807.937	Hand-cut rasp halfround 200 mm, 20x6 cut 5	53.76
CT-807.945	Hand-cut rasp halfround 150 mm, 10x4 cut 5	64.96
CT-807.920	Hand-cut rasp halfround 150 mm, 17x5 cut 5	64.96
CT-807.958	Hand-cut rasp halfround 150 mm, 16x4 cut 3	53.76
CT-807.959	Hand-cut rasp halfround 200 mm, 20x4 cut 3	66.08
CT-807.961	Hand-cut rasp halfround 150 mm, 10x4 cut 3	50.40



CT-807.957

NO.	DESCRIPTION	\$-NET
CT-807.957	Hand-cut rasp flat 150 mm, 16x4 cut 3	43.68

PLEASE INQUIRE ABOUT
QUANTITY DISCOUNTS



FILES & RASPS



CT-807.924

NO.	DESCRIPTION	\$\$-NET
CT-807.924	Hand-cut rasp cabinet 200 mm, 24x5 cut 3	64.96
CT-807.925	Hand-cut rasp cabinet 200 mm, 24x5 cut 4	64.96
CT-807.926	Hand-cut rasp cabinet 200 mm, 24x5 cut 5	66.08
CT-807.928	Hand-cut rasp cabinet 200 mm, 24x5 cut 7	88.48
CT-807.931	Hand-cut rasp cabinet 250 mm, 30x6 cut 4	99.68



CT-808.297



CT-808.261



CT-808.348



CT-808.265



CT-808.301

NO.	DESCRIPTION	\$\$-NET
CT-808.297	ROUND FILE diameter 2 mm sharp tip, cut 2, length 100 mm	9.28
CT-808.261	ROUND FILE diameter 1.8mm, sharp tip, cut 2, length 140 mm	12.35
CT-808.262	ROUND FILE diameter 3mm, sharp tip, cut 00, length 140 mm	7.19
CT-808.348	ROUND FILE diameter 3mm, sharp tip, cut 0, length 140 mm	7.19
CT-808.248	ROUND FILE dia 3mm, sharp tip, cut 1, length 140 mm	7.19
CT-808.264	ROUND FILE diameter 3.25 mm, sharp tip, cut 00, length 160 mm	7.82
CT-808.265	ROUND FILE diameter 3.5 mm, sharp tip, cut 00, length 180 mm	8.98
CT-808.266	ROUND FILE diameter 3.75 mm, sharp tip, cut 00, length 200 mm	10.17
CT-808.131	ROUND FILE diameter 3.75 mm, sharp tip, cut 1, length 200 mm	10.17
CT-808.301	ROUND FILE diameter 6mm cut 00 length 215 mm	9.64



CT-808.207



CT-808.250



CT-808.349

NO.	DESCRIPTION	\$\$-NET
CT-808.207	FLAT FILE 16x2 mm cut 0, cut length 150 mm	18.52
CT-808.210	FLAT FILE 21x5 mm cut 00, cut length 200 mm	23.36
CT-808.211	FLAT FILE 21x5 mm cut 0, cut length 200 mm	24.39
CT-808.227	HALF ROUND FILE 16x4.5 mm cut length 150 mm	33.88
CT-808.233	HALF ROUND FILE 12x3 mm, cut 00, cut length 100 mm	27.03
CT-808.244	FLAT FILE 5x1.3mm cut 1, length 140 mm	7.19
CT-808.250	HALF ROUND FILE 5.6x1.8 mm cut 1, length 160 mm	10.71
CT-808.349	FLAT FILE "BARET" shape width 5 mm, cut 0, length 160 mm	8.98
CT-808.350	HALF ROUND FILE 5.6x1.8 mm cut 0, length 160 mm	9.31

TOOLS



PATTERNS

The CORE Instrument Templates are meticulously derived from the most reliable sources available, including essential works by Sacconi, Hill, and other esteemed authorities. These templates undergo digital refinement to address wear issues, such as deformation around the soundpost, and to correct any irregularities in the original, ensuring a symmetrical make. The digitally derived arching counterlines represent the pinnacle of fidelity.



CT-842.610

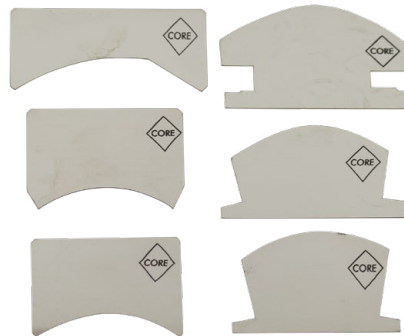

CT-842.604



CT-842.644



CT-842.656

TEMPLATES

NO.	DESCRIPTION	\$-NET
CT-842.623	Bass Neck Drilling Template	54.88
CT-842.604	Template Set 6-Piece	20.08
CT-842.607	Outlines Template Set Guarneri Kreisler 1733	42.56
CT-842.608	Outlines Template Set Strad Mediceo 1716	42.56
CT-842.610	Outlines Template Set Guarneri Kochanski 1741	42.56
CT-842.611	Outlines Template Set Guarneri Plowden 1735	42.56
CT-842.617	Top Archings Templates Guarneri Kreisler 1733	16.69
CT-842.619	Top Archings Templates Strad Mediceo 1716	16.69
CT-842.621	Outlines Template Set Montagnana Jarnacker 1729	66.08
CT-842.622	Outlines Template Set Strad Gore-Booth 1710	66.08
CT-842.637	Outlines Template Set Strad Axelrod 1695 15.5"	42.56
CT-842.638	Outlines Template Set Viola Guadagnini 1798	42.56
CT-842.639	Outlines Template Set Strad Spanish 1694	66.08
CT-842.644	Counterlines Template Guarneri Kreisler 1733	39.20
CT-842.645	Counterlines Template Strad Mediceo 1716	39.20
CT-842.646	Counterlines Template Viola Guadagnini 1798	39.20
CT-842.652	Top Archings Templates Viola Guadagnini 1798	16.69
CT-842.653	Top Archings Templates Montagnana Jarnacker 1729	22.29
CT-842.654	Back Archings Templates Guarneri Kreisler 1733	16.69
CT-842.655	Back Archings Templates Strad Mediceo 1716	16.69
CT-842.656	Back Archings Templates Viola Guadagnini 1798	16.69
CT-842.657	Back Archings Templates Montagnana Jarnacker 1729	22.29
CT-842.665	Top Archings Templates Guarneri Kochanski 1741	16.69
CT-842.666	Back Archings Templates Guarneri Kochanski 1741	16.69
CT-842.675	Top Archings Templates Guarneri Plowden 1735	16.69
CT-842.676	Back Archings Templates Guarneri Plowden 1735	16.69



PATTERNS



CT-842.764



CT-842.765



CT-842.766



CT-842.767



CT-842.768



CT-842.769

TOOLS

ITALIAN RIB MOLDS

NO.	DESCRIPTION	\$-NET
CT-842.764	Italian Rib Mold Guarneri Kreisler 1733	66.08
CT-842.765	Italian Rib Mold Guarneri Kochanski 1741	66.08
CT-842.766	Italian Rib Mold Guarneri Plowden 1735	66.08
CT-842.767	Italian Rib Mold Strad Mediceo 1716	66.08
CT-842.768	Italian Rib Mold Strad Axelrod 1695 15.5"	66.08
CT-842.769	Italian Rib Mold Guadagnini 1798	66.08



PLANES

CORE Luthier Finger planes and fingerboard planes boast solid brass bodies with HSS blades. Despite the slightly more time-consuming process of sharpening the HSS blades, the extended durability of the cutting edge justifies this effort. Available in various sizes and styles, featuring both flat and arched soles, as well as convex soles for fingerboard planing, these finger planes are equipped with a threaded hole in the back for the optional attachment of an auxiliary ball handle, facilitating easier work.



CT-805.770



CT-805.772



CT-805.713



CT-805.736



CT-805.768

FINGER PLANES

NO.	DESCRIPTION	\$/-NET
CT-805.764	Plane, curved sole, length 20mm, width 5mm.	36.68
CT-805.770	Plane, flat sole, length 20mm, width 5mm.	36.68
CT-805.734	Plane with wooden wedge, curved sole, length 20mm, width 5mm.	36.68
CT-805.714	Plane with wooden wedge, flat sole, length 20mm, width 5mm.	36.68
CT-805.765	Plane, curved sole, length 25mm, width 7mm.	36.68
CT-805.771	Plane, flat sole, length 25mm, width 7mm.	36.68
CT-805.788	Plane with adjustable mouth opening, curved sole, length 25mm, width 7mm.	49.33
CT-805.784	Plane with adjustable mouth opening, flat sole, length 25mm, width 7mm.	49.33
CT-805.736	Plane with wooden wedge, curved sole, length 25mm, width 7mm.	36.68
CT-805.716	Plane with wooden wedge, flat sole, length 25mm, width 7mm.	36.68
CT-805.766	Plane, curved sole, length 32mm, width 10mm, with hole.	36.68
CT-805.772	Plane, flat sole, length 32mm, width 10mm, with hole.	36.68
CT-805.789	Plane with adjustable mouth opening, curved sole, length 34mm, width 10mm. With hole.	61.98
CT-805.785	Plane with adjustable mouth opening, flat sole, length 34mm, width 10mm. With hole.	61.98
CT-805.738	Plane with wooden wedge, curved sole, length 32mm, width 10mm, with hole.	36.68
CT-805.718	Plane with Wooden wedge, flat sole, length 32mm, width 10mm, with hole.	36.68
CT-805.767	Plane, curved sole, length 40mm, width 12mm, with hole.	36.68
CT-805.773	Plane, flat sole, length 40mm, width 12mm, with hole.	36.68
CT-805.790	Plane with adjustable mouth opening, curved sole, length 40mm, width 12mm. With hole	61.98
CT-805.786	Plane with adjustable mouth opening, flat sole, length 40mm, width 12mm. With hole	61.98
CT-805.740	Plane with wooden wedge, curved sole, length 40mm, width 12mm, with hole.	36.68
CT-805.720	Plane with Wooden wedge, flat sole, length 40mm, width 12mm, with hole.	36.68
CT-805.768	Plane, curved sole, length 50mm, width 18mm, with hole.	49.33
CT-805.774	Plane, flat sole, length 50mm, width 18mm, with hole.	49.33
CT-805.791	Plane with adjustable mouth opening, curved sole, length 50mm, width 18mm. With hole.	74.64
CT-805.787	Plane with adjustable mouth opening, flat sole, length 50mm, width 18mm. With hole.	74.64
CT-805.742	Plane with wooden wedge, curved sole, length 50mm, width 18mm, with hole.	49.33
CT-805.722	Plane with wooden wedge, flat sole, length 50mm, width 18mm, with hole.	49.33
CT-805.769	Plane, curved sole, length 74mm, width 23mm.	74.64
CT-805.775	Plane, flat sole, length 74mm, width 23mm.	74.64
CT-805.746	Plane with wooden wedge, curved sole, length 74mm, width 23mm.	74.64
CT-805.713	Plane with wooden wedge, flat sole, length 74mm, width 23mm.	74.64



PLANES

PLEASE INQUIRE ABOUT
QUANTITY DISCOUNTS

REPLACEMENT BLADES FOR FINGER PLANES

NO.	DESCRIPTION	\$-NET
CT-805.904	Replacement blade for finger planes, curved sole, width 5mm	6.20
CT-805.737	Replacement blade for finger planes, curved sole, width 7mm	6.20
CT-805.906	Replacement blade for finger planes, curved sole, width 10mm	6.20
CT-805.907	Replacement blade for finger planes, curved sole, width 12mm	6.20
CT-805.908	Replacement blade for finger planes, curved sole, width 18mm	6.20
CT-805.909	Replacement blade for finger planes, curved sole, width 23mm	6.20
CT-805.604	Replacement blade for finger planes, flat sole, width 5mm	6.20
CT-805.717	Replacement blade for finger planes, flat sole, width 7mm	6.20
CT-805.606	Replacement blade for finger planes, flat sole, width 10mm	6.20
CT-805.607	Replacement blade for finger planes, flat sole, width 12mm	6.20
CT-805.608	Replacement blade for finger planes, flat sole, width 18mm	6.20
CT-805.609	Replacement blade for finger planes, flat sole, width 23mm	6.20
CT-805.745	Toothed blade for finger planes, curved sole, width 7mm	8.73
CT-806.016	Toothed blade for finger planes, curved sole, width 10mm	8.73
CT-806.017	Toothed blade for finger planes, curved sole, width 12mm	8.73
CT-806.018	Toothed blade for finger planes, curved sole, width 18mm	8.73
CT-805.747	Toothed blade for finger planes, curved sole, width 23mm	8.73
CT-805.744	Toothed blade for finger planes, flat sole, width 7mm	8.73
CT-805.706	Toothed blade for finger planes, flat sole, width 10mm	8.73
CT-805.707	Toothed blade for finger planes, flat sole, width 12mm	8.73
CT-805.708	Toothed blade for finger planes, flat sole, width 18mm	8.73
CT-805.709	Toothed blade for finger planes, flat sole, width 23mm	8.73



CT-805.904



CT-805.737



CT-805.907



CT-805.745



CT-805.708

BALL HANDLE



NO.	DESCRIPTION	\$-NET
CT-805.723	Ball Handle. This is a handle designed for finger planes. It has an M5 threaded end that fits into holes in planes with screw caps and wooden wedges (32, 40, and 50 mm long) and fingerboard planes. The ball-shaped end allows smooth and precise control of the plane while working. You can easily attach and remove it. Plus, the handle's length is adjustable to fit any palm size.	17.92

OTHER PLANES

NO.	DESCRIPTION	\$-NET
CT-805.759	Block plane with tongue-shaped handle, body 85*32, blade thickness 2.5mm/width 24mm	94.87
CT-805.760	Replacement blade for block plane with tongue-shaped handle, flat sole, width 24mm.	13.91
CT-805.761	Block plane, body 85*32, blade thickness 2mm/width 24mm	87.29
CT-805.762	Replacement blade for block plane, flat sole, width 24mm.	12.52
CT-805.758	Fingerboard plane, concave arched sole, plane length 50mm, blade width 18mm, with hole.	61.98
CT-805.711	Replacement blade for fingerboard plane, width 18mm.	8.73
CT-805.763	Fingerboard plane with handle, concave arched sole, body 84*32, blade width 23mm.	74.64
CT-805.712	Replacement blade for fingerboard plane with handle, concave arched sole, width 23mm.	8.88
CT-805.733	Replacement blade for micro-finger plane, curved sole, width 4mm.	6.96
CT-805.752	Fingerboard block plane, length 135mm, blade width 30mm	99.94
CT-805.729	Wooden bow maker's plane, blade width 30mm.	74.64
CT-805.719	Replacement blade for wooden bow maker's plane, blade width 30mm.	15.18
CT-805.753	Replacement for fingerboard block plane, width 30mm.	15.18



CT-805.759



CT-805.729

TOOLS



PURFLING ROUTER JIG

NO.	DESCRIPTION	\$-NET
CT-804.311	A purfling router jig for the Dremel 3000 Motor with a removable copying routing head. The accurate head allows precise adjustment of routing depth and edge width. Comes with a 1/8" shaft router bit collet. Maximum 10mm distance between ball-bearing edge and router axis	99.68



RAZORSAWS



CT-760.010



CT-760.011



CT-760.012



CT-760.013



CT-760.100

CT-760.111

NO.	DESCRIPTION	\$-NET
CT-760.010	Razorsaw Blade length 180mm, thickness 0.3mm, tooth spacing 1.5mm	22.29
CT-760.011	Razorsaw Blade length 180mm, thickness 0.5mm, tooth spacing 1.5mm	22.29
CT-760.012	Razorsaw Blade length 100mm, thickness 0.3mm, tooth spacing 1.0mm	18.93
CT-760.013	Razorsaw double Edge Japanese Saw Blade length 125mm, thickness 0.3mm, tooth spacing 1.0mm & 1.3mm	20.05
CT-760.100	Replacement blade for CT-760.010. Length 180mm, thickness 0.3mm, tooth spacing 1.5mm	13.33
CT-760.111	Replacement blade for CT-760.011. Length 180mm, thickness 0.5mm, tooth spacing 1.5mm	13.33

TOOLS



MISCELLANEOUS VIOLIN MAKER'S TOOLS



CT-807.135



CT-807.136



CT-809.034



CT-807.138

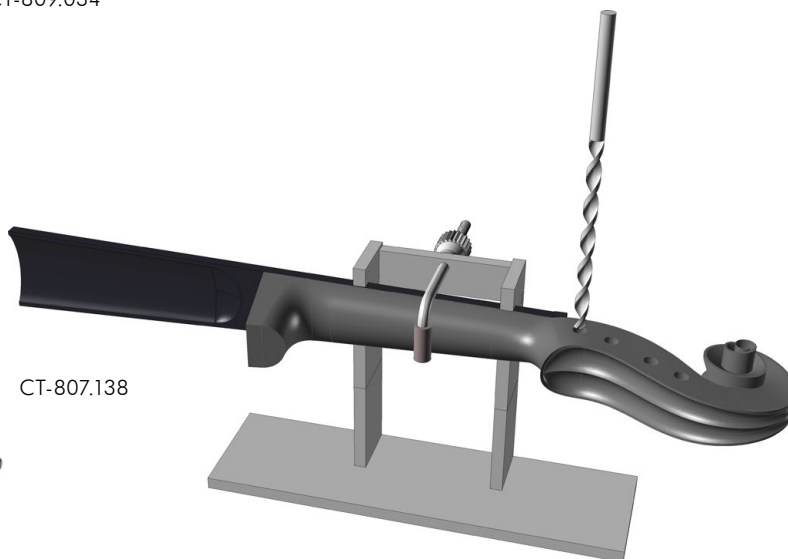

VIOLIN MAKER'S TOOLS

NO.	DESCRIPTION	\$.-NET
CT-807.135	Violin maker's work base violin with 5 adjustable side supports: 2 upper bout, 2 lower bout, 1 lower block. The Luthier's Bowl, a tool well-known to every maker, is enhanced with a ball-head mount for effortless use, streamlining the arching creation process.	99.94
CT-807.136	Violin maker's work base cello with 5 adjustable side supports: 2 upper bout, 2 lower bout, 1 lower block.	251.73
CT-809.034	Ball mount for luthier's work base.	110.88
CT-807.138	Drilling jig for violin neck. Simplify the process of drilling holes into the peg-box with the CORE Drilling Jig. Ensuring proper direction and position, the jig aligns the neck's axis perfectly perpendicular to the vertical axis of the drilling bit. Particularly useful for re-drilling holes after the installation of bushings.	99.68

TOOLS



CORE BOWMAKER TOOLS



CT-803.812



CT-803.813



CT-803.810



CT-803.811



CT-805.726



CT-805.727

PURFLING CHANNEL TOOLS

CORE purfling channel cleaners are constructed of carbon steel and hardened to HRC 52, which allows for a delicate tip to be retained. The cutting blade is gently tapered to allow for easy movement even in the curved areas of the purfling channel. This tool is available in two thicknesses, allowing for more precise work on all violins, violas, cellos, and basses.

The CORE channel cutter appears to be comparable to most OEM cutters, however it has precision one-side beveled blades measuring only 0.6 mm each. This enables the design of a configuration for cutting a 1.2 mm purfling channel with the straight side of the blade.

NO.	DESCRIPTION	\$-NET
CT-803.812	Purfling Channel Cleaner Straight With Maple Handle 1.2mm	24.84
CT-803.813	Purfling Channel Cleaner Straight With Maple Handle 1.8mm	24.84
CT-803.810	Purfling Channel Cleaner Curved With Maple Handle 1.2mm	45.02
CT-803.811	Purfling Channel Cleaner Curved With Maple Handle 1.8mm	45.02
CT-805.726	Purfling Channel Cutter	85.39
CT-805.727	Inlay Cutter Blades	29.50

MISCELLANEOUS VIOLIN MAKER'S TOOLS

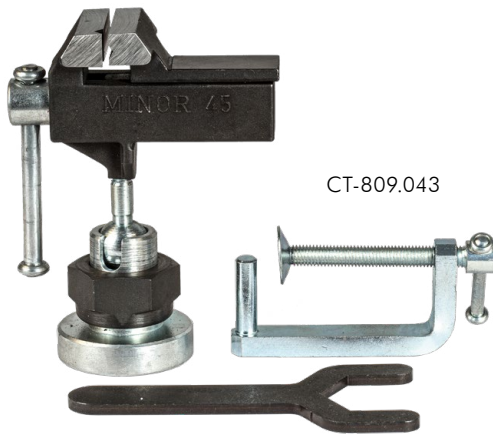

CT-809.043



CT-810.208

VIOLIN MAKER'S TOOLS

NO.	DESCRIPTION	\$-NET
CT-809.043	Bench mounted mini vice with ball hinge. A miniature vise, easily mountable and dismountable from the workbench, facilitates comfortable work on saddles, bridges, and other small and delicate parts.	99.68
CT-810.208	Neck Projection Gauge	88.48

TOOLS



Table of Contents for Pages H46 - H78:

Peg Reamers & Shapers.....	H46 - H47
Endpin Reamers.....	H48
Electric Router	H48
Knives & Sharpening Stones.....	H49 - H50
Glue Pots and Spirit Lamps.....	H51
Glue, Glue Brushes	H52
Rasps	H53 - H54
Scrapers, Awl	H55
Files	H56 - H57
Workbenches	H58
Core Shop Apron, Hammers.....	H59
Planes	H60 - H61
Measuring Tools (calipers, rulers, compasses, etc.)	H62 - H63
Micro-Mesh	H64
Saws	H65
Gouges & Chisels.....	H66 - H67
Instrument Holders/Work bases	H68
Bridge Tools	H69
Soundpost Setters	H70
Inspection Lamps & Mirrors	H70
Clamps.....	H71 - H76
Patterns & Templates	H77
Purfling Tools; Bending Irons; String Winders	H78
UPDATES PAGE (electronic version only)	H79

PLEASE INQUIRE ABOUT
QUANTITY DISCOUNTS



AMERICAN MADE PEG HOLE REAMERS

no.	description	\$-net
730500	Violin	91.80
730600	Cello	177.30



AMERICAN PEG SHAPERS

Adjustable shapers, cuts all sizes from 1/4 - 4/4 violin & viola. Cello shaper cuts all size Cellos

no.	description	\$-net
730105	Violin	126.00
730205	Cello	171.00



BLADES FOR AMERICAN MADE PEG SHAPERS

no.	description	\$-net
230	Violin, for American model	18.00
231	Cello, for American model	27.00

MORE REAMERS, TAPER PIN, DRILL BIT, ROUTER

no.	description	\$-net
730525	Taper pin , or burnisher, for peg hole bushing - violin. Taper 1/20, Ø 10.0 mm - 4.5 mm, length 165 mm.	77.95
735666	Spiral peg hole reamer , violin/viola.	126.00
735666T	Peg hole reamer . Like above, with TiN coating.	126.00

SEE PAGE H-5 FOR ELECTRIC ROUTER



MORE SHAPERS & REAMERS

item #	description	\$-net
GW466005	Peg reamer, violin. Taper 1:30. Three cutting edges, cut length 135 mm. Ø 5.5 - 9.5 mm.	115.78
GW465950	Peg reamer, cello. Taper 1:25. Three cutting edges, cut length 200 mm. Ø 8.0 - 16.0 mm.	115.78
GW466048	Peg reamer, cello. Taper 1:25. Three cutting edges, cut length 195 mm. Ø 10.0 - 16.5 mm.	173.67
GW466060	Endpin reamer, cello. Taper 1:17. Three cutting edges, cut length 160 mm. Ø 16.0 - 25.5 mm.	290.50
GW466100	Peg shaper, violin. Taper 1:30. Ø 7.5 - 9.2 mm, cut length 50 DISCONTINUED	
GW466101	Replacement blade for #GW466100, above.	70.17



TOOLS



ALL TOOL PRICES ARE NET!!

**HERDIM
PEG SHAPERS**

The seven models we offer each feature a range of peg hole sizes, allowing them to cover the whole range of peg sizes, from the smallest violin to the largest cello. The brass bodies are fitted with double-sided blades which display high cutting performance and excellent edge-holding properties. Re-sharpening of the blades is not recommended due to the differential hardening of the cutting edges. The soft plastic case provides a comfortable, non-slip grip. All peg shapers come with instructions for use and a key for adjusting the blade.

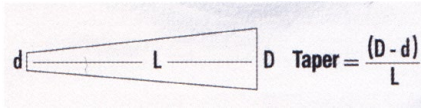

VIOLIN STANDARD, TAPER 1/30
(Matching reamer #s: 730502, 730512, 730522, 730532)

For 3/4 - 4/4 Violin/Viola.
Length of the holes: 50 mm.
Size (thick end): 8.0 / 8.5 / 9.0 / 9.5 mm.
Weight: 540 g.

no.	\$-net
730102	236.81

CELLO SMALL, TAPER 1/25
(Matching reamer #s: 730601, 730611, 730621, 730631, 730505)

For 1/8 - 1/4 Cello & Violin.
Length of the holes: 80 mm.
Size (thick end): 10.75 / 11.5 mm.
Weight: 690 g.

no.	\$-net
730201	209.77

LUTE / VIOLA DA GAMBA, TAPER 1/25
(Matching reamer # 730505)

For Lute and Viola da Gamba.
Length of the holes: 80 mm.
Size (thick end): 9.2 / 7.7 mm.
Weight: 600 g.

no.	\$-net
730204	209.76

VIOLIN SMALL, TAPER 1/30
(Matching reamer #s: 730501, 730511, 730524, 730531)

For 1/16 - 3/4 Violin.
Length of the holes: 50 mm.
Size (thick end): 6.0 / 6.5 / 7.0 / 7.5 mm.
Weight: 590 g.

no.	\$-net
730101	239.04

CELLO MEDIUM, TAPER 1/25
(Matching reamer #s: 730601, 730611, 730621, 730631)

For 1/4 - 3/4 Cello.
Length of the holes: 80 mm.
Size (thick end): 12.25 / 13.0 mm.
Weight: 640 g.

no.	\$-net
730202	209.76

"HERDIM" MULTI PEG SHAPER

The "HERDIM" MULTI is the most sophisticated peg shaper for professional restoration. By adjustment of diameter and taper pegs can be shaped to match given peghole sizes. Less or no trimming of the peg hole saves working time and - even more important - saves the scroll substance. Also ideal for trimming peghole bushings and for historical instruments.

Separate adjustment nuts for taper and diameter. Machined in ultimate precision from aircraft aluminum alloy, anodized. Razor-like one-way blades for a perfectly smooth surface. Satisfaction guaranteed!
Taper: 1/15 - 1/100.

no.	description	\$-net
730800	Violin / viola, Ø 6.0 - 12.0 mm, length 50 mm.	504.09
730801	Cello, Ø 10.0 - 15.0 mm, length 80 mm.	671.79

VIOLIN IRREGULAR, TAPER 1/20
(Matching reamer #s 730503, 703513, 703523, 703533)

For 1/8 - 4/4 Violin/Viola.
Length of the holes: 50 mm.
Size (thick end): 7.25 / 8.0 / 8.75 / 9.5 mm.
Weight: 560 g.

no.	\$-net
730103	193.98

CELLO LARGE, TAPER 1/25
(Matching reamer #s 730601, 730611, 730621, 730631)

For 3/4 - 4/4 Cello.
Length of the holes: 80 mm.
Size (thick end): 13.75 / 14.5 mm.
Weight: 600 g.

no.	\$-net
730203	209.76

**SPARE BLADES FOR
HERDIM PEG SHAPERS**

Heavier, best quality carbon steel, tempered to extreme hardness, two cutting edges.

no.	description	\$-net
730100	for violin, #s 730101-103 & 730800	6.77
730200	for cello, #s 730201-204 & 730801	8.09
730109	for violin, #s 730101-103 & 730800	19.14
730209	for cello, #s 730201-204 & 730801	22.77

WITTNER PEG SHAPER KIT

For violin & viola. 7.0 mm - 9.4 mm.
Cone - 1:20, 1:25, 1:30. Width of blade - 51 mm. Use with Wittner Ultra Pegs, or with any wooden pegs. Ø 0.275" - 0.370".

no.	description	\$-net
730111	Wittner peg shaper kit.	195.81
278	(2) replacement blades.	65.31

PEGBOX REPAIR TOOL KIT

Alternate method for repairing pegbox cracks. Precise circular saw with centering sleeves for installing brass ring around problem area. Reinforces without cheek graft. Kit includes tools and 10 brass rings. In attractive wooden box.

no.	\$-net
470002	360.17

Spare parts:

no.	description	\$-net
470002-RVC	Rings for cello, brass	1.70
470002-RVN	Rings for violin, brass	1.30
470005-RVC	Rings for cello, titanium	6.25
470005-RVN	Rings for violin, titanium	5.00

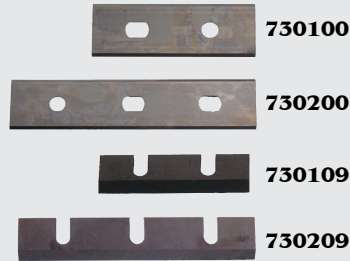

TOOLS



HERDIM PEG HOLE REAMERS**NEW LOWER PRICES !!****ALL TOOL PRICES ARE NET!!**

For trimming and finishing peg holes. Made of high-speed steel (hardened to 62 RC), the cutting edge is abrasion resistant even under excessive use. Our Peghole Reamers come with 3 cutting edges only, which is best for achieving perfectly round holes. Together with our Peg Shapers they give you a precise fit of pegs and peg holes.

Straight cutting edges are particularly sharp and guarantee perfectly round holes.

Spiral cutting edges allow for previously unheard of cutting quality. The wood fibers are at an angle which makes these reamers completely chatter-free, ensuring perfectly round holes. This is especially important for old instruments with very hard medullary rays and sensitive peg-box walls. Polished rosewood handles.

TiN Coating (titanium-nitride) provides a three-fold improvement in the reamer's edge life, protects it from corrosion and reduces friction during use. By allowing a smoother and gentler cut, it also reduces the stress placed on the pegbox. The sharpness is not affected by the coating in any way.

**VIOLIN PEG HOLE REAMERS (VIOLA TO 1/2 SIZE VIOLIN)
STANDARD TAPER 1/30 (Matching Shaper: #730102)**

no.	description	\$-net
730502	Violin Standard, Taper 1/30 \emptyset 5.5/10mm, length 135 mm.	108.60
730512	TiN-coated Violin Standard	134.38
730413	Herdim Violin Standard, TiN-coated, taper 1/30.	162.44
730522	Normal, standard violin/viola, spiral .	121.35
730532	TiN-coated, standard violin/viola, spiral .	145.28

**VIOLIN PEG HOLE REAMERS (1/2 - 1/16 SIZE VIOLIN)
SMALL TAPER 1/30 (Matching Shaper: #730101)**

no.	description	\$-net
730501	Violin Small, Taper 1/30 \emptyset 4.0/7.5mm, length 105 mm.	90.52
730511	TiN-coated Violin Small.	114.97
730524	Normal, small violin, spiral .	105.41
730531	TiN-coated, small violin, spiral .	124.20

**VIOLIN PEG HOLE REAMERS (VIOLA TO 1/2 SIZE VIOLIN)
IRREGULAR TAPER 1/20 (Matching Shaper: #730103)**

no.	description	\$-net
730503	Violin, Taper 1/20 (irregular) \emptyset 3.5/10mm, length 130 mm.	112.84
730513	TiN-coated, irregular violin.	133.92
730523	Normal, 1/20 irregular violin, spiral .	133.92
730533	TiN-coated, 1/20 irregular violin, spiral .	136.95

**CELLO PEG HOLE REAMERS,
(Matching Shaper: #730201-03 & 730801)**

no.	description	\$-net
730601	Cello, Taper 1/25 \emptyset 8/16mm, length 200 mm.	161.38
730621	Normal, 1/25 standard cello, spiral .	189.21
730631	TiN-coated, 1/25 standard cello, spiral .	231.00

**LUTE / VIOLA PEG HOLE REAMERS,
(Matching Shaper: #730601)**

no.	description	\$-net
730505	Lute peghole reamer.	178.22

HERDIM TAPER PINS

Taper pins are for setting ring-shaped peg hole bushings and for smoothing the surfaces of the holes. Made of tool steel with precision-ground conical pin.

no.	description	\$-net
730521	Violin, taper 1/30, 10 X 4.5 mm diameter, length 165 mm.	77.95
730622	Cello, taper 1/25, 15 X 6 mm diameter, length 225 mm.	184.60

**REAMER HANDLES**

no.	description	\$-net
7300396	Rosewood, for reamers with hexagonal shaft, knob shape, \emptyset 40 mm.	11.96
7300398	Rosewood, for reamers with hexagonal shaft, spindle shape, violin.	21.80
7300399	Boxwood, for reamers with hexagonal shaft, spindle shape, cello.	29.15



HERDIM ENDPIN REAMERS

Herdim Endpin Reamers come in longer sizes to cover a wider span of endpin diameters and allow more varied use. The Cello Endpin Reamer which overlaps with the Peghole Reamer may also be used for enlarging peg holes for bushings. All reamers are made of high speed steel, tempered to HRC 61, for a sharp and durable cutting edge.

CELLO ENDPIN REAMERS

Taper 1/17, Ø 15.0/27.5 mm, length 212.5 mm.
(also suited for cello peghole bushings).

no.	description	\$-net
730701	Straight, uncoated.	288.95
730721	Spiral, uncoated.	295.14
730731	Spiral, TiN coated.	379.47

BASS ENDPIN REAMERS

Taper 1/17, Ø 23.0/36.0 mm, length 221 mm.

no.	description	\$-net
730702	Straight, uncoated.	421.63
730732	Spiral, TiN-coated.	626.25

BASS ENDPIN REAMER, OVERSIZED

For bushings.
Taper 1/17, Ø 46.0/33.0 mm, length 221 mm.

no.	description	\$-net
730722	Spiral, TiN coated.	891.80

CELLO / BASS ENDPIN REAMER

Combination cello & bass reamer.
Taper 1/17, Ø 39.0/20.0 mm, length 323 mm.

no.	description	\$-net
730703	Straight, uncoated.	860.26



HERDIM STOP RING FOR PEGHOLE REAMER

no.	\$-net
730431	6.77

ORDER ONLINE !!
www.howardcore.com

AMERICAN MADE CELLO ENDPIN REAMER

no.	description	\$-net
730700	Cello endpin reamer. Taper 1:17, length 200 mm.	270.00



HERDIM STOP RING FOR PEGHOLE REAMER

no.	\$-net
730431	6.77



ROUTER

item #	description	\$-net
GW481902	Portable router. Perfect for milling out purfling channel. Includes two cutter bits (1.5 mm & 2.0 mm), and adjustable catch (3.5 - 5.5mm). 110 V.	395.00
GW481903	Replacement bit - 1.5 mm.	22.45
GW481905	Replacement bit - 2.5 mm.	22.45



GW481902

Cremona Tools Available - Please Call !!



SHARPENING STONES

no.	grit	size in mm	\$-net
711001	"King" 800 Sharpening	207 x 66 x 34	43.40
711002	"King" 1200 Sharpening	207 x 66 x 34	43.73
711004	"King" 8000 Honing	185 x 62 x 19	94.51
711005	"King" combination stone; 1000/6000 - Grinding/finishing	205 x 50 x 25	60.83
705366	Diamond sharpening stone		91.18
711546	Cerax combination stone 1000/6000, with base.	183 x 63 x 32	109.28



BELGIAN WHETSTONES

no.	size in mm	\$-net
705556	150 x 40 x 20	139.95
705557	75 x 30 x 20	25.71



HONING CONE

no.	description	\$-net
705393	Cone-shape, fine grit half-round diamond coated sharpener. Out-side coated only. Ø 9.5 - 19.3 mm. Length 152 mm.	62.61



NAGURA STONE CONDITIONER

no.	description	\$-net
711302	Synthetic stone for cleaning and unclogging the surface of the sharpening stones and for creating a fine polishing paste.	10.44

CHOPPING KNIFE

item #	description	\$-net
GW481300	Chopping knife with leather handle. 22.5 cm length.	35.28

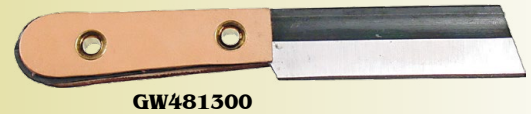

JAPANESE KNIVES (KOGATANA DELUXE)

Japanese cutters of fine quality laminated steel, easier to resharpen and less brittle than "Western" cutters. The blade is tempered to a hardness of 60° - 61° Rockwell and trimmed to a razor-like cutting edge. The beveling is either on both sides for versatile application or on one side only. The one-sided bevel should be preferred if extreme cutting precision is demanded (i.e. veneer of inlay work or marking cuts).

Kogatana come without handles. We recommend to wrap the blades with, according to Japanese habit, a leather strip or fix a slim wooden handle.

These are hand forged by master Shozo Ikeuchi Lo in traditional style. By multiple folding of the steel a "woodgrain" pattern is achieved ("Damascus" steel) and the strength and durability of the blade is considerably improved.

	bevel: both sided		bevel: left		bevel: right	
width	no.	\$-net	no.	\$-net	no.	\$-net
18 mm	710501	111.43	-----	-----	-----	-----
15 mm	710506	95.49	-----	-----	-----	-----
12 mm	710502	113.68	-----	-----	-----	-----
6 mm	710504	96.26	-----	-----	-----	-----
3 mm	710505	95.49	710515	88.62	-----	-----



JAPANESE CARVING KNIFE SET

item #	description	\$-net
TL-16S	Japanese carving knife set - six knives. Includes right-, left-, and double-bevel 30 mm blade knives, right- and left-bevel 60 mm blade knives, and 12 mm flat chisel. Overall length approximately 150 mm. Leather sheaths, in canvas pouch.	243.80



HERDIM HSS WOODWORKING KNIVES

HRC 65 steel. 2 mm thick, 160 mm length.

no.	width	\$-net
700371	6 mm	28.39
700373	8 mm	31.31
700375	15 mm	38.80



PFEIL WOODWORKING KNIVES

Made of alloyed Swiss steel. Approx. 59-60 HRC, double bevel. Length 160 mm, blade thickness 2 mm. Rosewood handle.

no.	width	\$-net
700390	3.5 mm	45.43
700391	6 mm	45.43
700392	9 mm	45.43
700393	12 mm	45.43
700394	15 mm	45.43
700395	19 mm	60.98
700401	3.5 mm - blade only	22.39
700403	9 mm - blade only	22.39



SABATIER WOODWORKING KNIVES

Sabatier is one of the oldest manufacturers of knives and other high-performance cutting tools in France. The blades of these knives are made of XC 100 stainless surgical steel, hardened to approximately 62 RC, and come sharpened and ready to use. The tapered, polished Macassar ebony handles are securely held in place by brass rivets. Blade length 70 mm, overall length 180 mm, blade width approximately 24 mm.

no.	description	\$-net
700411	Double bevel	61.79
700412	Right bevel (for left-handed users).	61.79
700413	Left bevel (for right-handed users).	61.63



SEAM SEPARATION KNIFE

no.	description	\$-net
4465	Ideal for removing tops and backs! 3.75" x 0.75" high carbon steel blade.	18.75



HERDIM OPENING CHISEL

Using this tool makes opening of the instrument an easy task. Tapered blade can be easily bounced with hammer on the thicker (2 mm) end, very thin blade 0.4 mm easily opens the plate-rib joint. The corner and endblocks can be gently opened from the inside of the instrument, which reduces the danger of cracks and snaps. The cutting edge is slightly curved and beveled on both sides. Hardness 59 HRC, stainless.

Blade width 23 mm, Overall length 170 mm.

no.	\$-net
700376	78.50



**PLEASE INQUIRE ABOUT
QUANTITY DISCOUNTS**

ALL TOOL PRICES ARE NET!!



ELECTRIC GLUE POT & WARMER SET

This double-boiler pot surrounds the inner pot with water to evenly distribute heat and help prevent scorching of the glue, even when placed on a constant heat source. The water also helps insulate it to retain warmth when removed from the heat source. The removable inner pot holds up to 1 fl oz of glue, and the outer pot holds 2 1/2 fl oz of water. Measures 3" in diameter and 2 3/8" tall overall. The included electric tabletop warmer keeps the glue warm for longer periods. This small ceramic hotplate has a 39" long cord and can be used safely on any flat surface.

no.	description	\$-net
09A0284	Glue pot & tabletop warmer set. 110V.	68.00

**CONTAINERS & LIDS**

no.	description	\$-net
736000	Glue kettle, ceramic, for HERDIM glue pots. Volume: 0.25 liter.	17.71
736005	Clear lab glass glue kettle for HERDIM glue pot. Volume: 0.25 liter.	32.59
736007	Plastic double-chambered containers for simultaneously heating glue and water (for thinning purposes). Polypropylene - tough, heat resistant, and chemically neutral. 1.0 liter.	17.55
736015	Asymmetrical, double-chambered containers, 1/3 divided, for simultaneously heating glue and water (for thinning purposes). Made of polypropylene; tough, heat resistant and chemically neutral. Capacity 0.25 liter.	9.74
736016	Plastic lid for use with #736016, above. Has hole for brush.	7.49

**SPIRIT LAMPS & WICKS**

no.	description	\$-net
706003	Steel spirit lamp w/ wick rack & handle. Vol. 120 ccm. Burns up to 6 hours. (for Herdim Glue Pot no. 736102).	121.79
706008	Glass container, 120 ccm capacity, burning time ca. 2-3 hours. Can be set upright or at an angle due to the polygonal base. 120 ccm capacity, round wick Ø 12 mm, with cap.	35.25
706009	15 cm wick for #706008 lamp.	3.88
706013	Glass container with dial regulator, 120 cm ³ capacity, burning time approx. 2-3 hours. Can be set upright or at an angle due to its polygonal shape. Round wick Ø 6 mm, with cap.	29.94
706014	15 cm replacement wick for item #706013, above.	2.99



706003



706008



706013



706014



GLUE BRUSHES - HORSETAIL HAIR

Corrosion free thread winding. No glue blackening. Suitable for those with nickel allergies.

no.	size	\$-net
GW464750	10 mm - no metal.	13.29
GW464760	14 mm - no metal.	13.29



GW464760

ALL TOOL PRICES ARE NET!!

ORDER ONLINE !!
www.howardcore.com

ANIMAL GLUES

Animal glues have been used by woodworkers for over 4,000 years. They are completely non-toxic, non-ageing, are easily reversible by heat and therefore ideal for repair work. The use of these glues is relatively uncomplicated. The most important criterion is an even, controlled heating process and the maintenance of a defined temperature range (about 60° - 70° Centigrade or 140° to 158° Fahrenheit) which keeps the proteins from degenerating.

no.	description	\$-net
G50-411	High clarity hide glue. Milligan & Higgins. 411 gram strength - highest strength, shorter open time. 1 lb bag.	10.64
G50-251	High clarity hide glue. Milligan & Higgins. 251 gram strength - high strength, medium open time. Ideal for repair work. 1 lb bag.	9.68
G50-192	High clarity hide glue. Milligan & Higgins. 192 gram strength - regular strength, longest open time. Ideal for new construction. 1 lb bag.	9.30
G51	Rabbit glue, higher viscosity than hide glue, strongest bonds. 500 gram bag. (approximately 1 lb.)	29.51
G53	Animal bone glue. 1 kilogram (2.2 lbs).	18.11



G50



G51



G53

TOOLS



HERDIM PRECISION RASPS, HANDCUT

Rasps come in where shaping no longer follows the laws of plane geometry. Therefore, they are equally indispensable for the cabinet maker, the violin maker, model builder or stuccoist. The best rasps are still cut by hand. Each tooth is formed individually with hammer and chisel and no two teeth are exactly the same. It is precisely this slightly irregular tooth configuration that ensures the smooth removal of wood and avoids clogging of the rasp. You can use these tools not only for hard and soft wood but also for leather, plastic, plaster and soft metal. Hard carbon steel body, tempered tang. As they are handcrafted, the sizes of these rasps may vary slightly. **Cut 3=coarse, 4=medium, 5=fine, 10=extra fine.**

1 Flat rasp (with handle tang)

number	cross section	cut length	cut	\$-net
704505	25 x 5 mm	200 mm	3	104.08
704506	25 x 5 mm	200 mm	4	97.26
704507	25 x 5 mm	200 mm	5	106.12

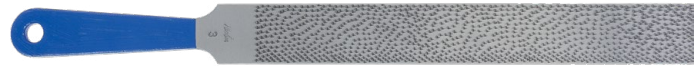
**704505****2 Flat rasp**

number	cross section	cut length	cut	\$-net
704502	10 x 4 mm	125 mm	5	60.06
704704	16 x 4 mm	150 mm	5	68.91
704707	20 x 5 mm	200 mm	5	93.72

**704502****ALL TOOL PRICES ARE NET!!****3 Cabinet rasp**

number	cross section	cut length	cut	\$-net
704716	17 x 4 mm	150 mm	5	83.09
704720	27 x 5 mm	200 mm	3	88.40
704721	27 x 5 mm	200 mm	4	107.69
704722	24 x 5 mm	200 mm	5	106.87
704724	Herdim "Ultra" 24 x 5 mm	200 mm	10	175.38

**704720****4 Half-round rasp**

number	cross section	cut length	cut	\$-net
704732	16 x 6 mm	150 mm	5	70.91
704733	20 x 6 mm	200 mm	5	113.38

**704732****5 Half-round rasp, slim**

number	cross section	cut length	cut	\$-net
704741	10 x 4 mm	150 mm	5	67.14

**704741****GEWA FILE**

item #	description	\$-net
GW482261	Precision flat file, 200 mm length, cut 1.	81.12

**GW482261****GW482263**

HANDMADE CHINESE RASPS

Handmade Chinese rasps. The irregular surface gives an exceptionally effective cutting action for coarse work. Sharp, stable cut. Hardened and chromed rasps which can be bent within limits to permit a wide range of uses. Made of C45 carbon steel.

HATTORI FLAT RASP WITH HANDLE TANG

item no.	cross section	cut length	cut	\$-net
704571	24 x 4 mm	200 mm	3 coarse cut	15.47



704571

HATTORI CABINET RASP

item no.	cross section	cut length	cut	\$-net
704572	25 x 5 mm	200 mm	3 coarse cut	13.18



704572

SCRAPERS

item no.	description	\$-net
703500	Set of scrapers - 7 pieces. 0.4 mm thickness. Blades made of Swedish steel.	52.60

703500

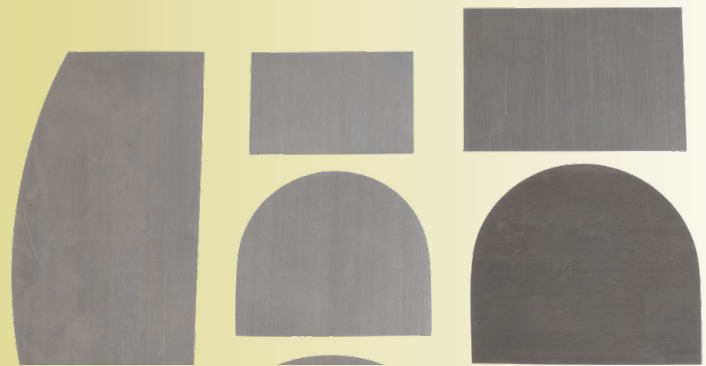

SCRAPERS "EBERLE"

Spring steel, approximately 50 HRC, excellent blade durability.

no.	description	thickness	\$-net/each
703507	Rectangular, 150 mm x 50 mm.	0.25 mm	4.75
703502	Rectangular, 150 mm x 50 mm.	0.40 mm	5.32
703504	Rectangular, 150 mm x 50 mm.	0.60 mm	5.32
703510	Goose neck, 130 mm x 70 mm.	0.60 mm	8.52
703505	Rectangular, 150 mm x 50 mm.	0.80 mm	4.91
703506	Rectangular, 150 mm x 50 mm.	1.00 mm	5.41



703510

TOOLS

KUJIRI PUNCH AWL

no.	description	\$-net
717205	White oak handle. Drift length is 55 mm, overall length 105 mm.	13.12



717205

ORDER ONLINE !!
www.howardcore.com

ALL TOOL PRICES ARE NET!!



GLARDON/VALLORBE FILES

The traditional Swiss Glardon/Vallorbe company (formerly Grobet-Swiss) makes top-quality precision files which meet the high quality standards of the watch industry. 200 years of experience come to the fore in excellent durability and sharpness. The files are designed for working steel, but they are equally suitable for fine working of wood, aluminum, brass and hard plastics. Hardened to 64-65 HRC. Although these files were originally developed for watch makers they are exceptionally well suited for woodworking, also. The workmanship and edge-holding ability of their cuts are of superb quality.



eight inch hand files used by bowmakers

TABLE OF CUTS

	for	German cut no.	Swiss cut no.
coarse	wood	1	000 - 0
medium	wood	2	0 - 1
fine	wood/metal	3	1 - 2
very fine	metal	4	2 - 3
ultra fine	metal	5	3 - 4

The density and height of the cutting edges depend on the cut number AND the length of the file.

CROSS FILES

Hardened to 64-65 HRC.

no.	cross section	cut length	cut	\$-net
705030	15 x 4.5 mm	150 mm	0	109.44
705031	15 x 4.5 mm	150 mm	1	100.05
705032	21 x 6 mm	200 mm	00	142.90
705033	21 x 6 mm	200 mm	0	160.81

FLAT FILES

DOUBLE CUT Swiss

number	cross section	cut length	cut	\$-net
705003	17 x 2 mm	150 mm	00	48.29
705004	17 x 2 mm	150 mm	0	49.64
705005	17 x 2 mm	150 mm	1	52.55
705078	17 x 2 mm	150 mm	2	51.22
705192	19 x 4 mm	150 mm	00	39.24
705193	19 x 4 mm	150 mm	0	42.35
705194	19 x 4 mm	150 mm	1	36.46
705012	22 x 5 mm	200 mm	000	59.82
705006	22 x 5 mm	200 mm	00	55.66
705007	22 x 5 mm	200 mm	0	57.65
705008	22 x 5 mm	200 mm	1	62.56
705013	22 x 5 mm	200 mm	2	64.40
705014	22 x 5 mm	200 mm	3	68.05
705035	22 x 5 mm	200 mm	4	68.05
705039	26 x 6.5 mm	250 mm	000	76.13
705009	26 x 6.5 mm	250 mm	00	82.30
705010	26 x 6.5 mm	250 mm	0	78.52

HALF-ROUND FILES

number	cross section	cut length	cut	\$-net
705020	13 x 4 mm	125 mm	0	78.94
705022	15 x 4.5 mm	150 mm	00	77.48
705023	15 x 4.5 mm	150 mm	0	72.35
705024	15 x 4.5 mm	150 mm	1	85.58
705068	15 x 4.5 mm	150 mm	2	95.60
705069	15 x 4.5 mm	150 mm	3	86.10
705086	21 x 6 mm	200 mm	000	96.86
705026	21 x 6 mm	200 mm	0	95.86
705027	21 x 6 mm	200 mm	1	101.84
705087	21 x 6 mm	200 mm	2	112.21

SLIM (FOR BOW TIPS, F-HOLES, ETC.) Hardened to 64-65 HRC.

705028	10 x 3 mm	150 mm	0	81.51
705029	10 x 3 mm	150 mm	2	91.48
705074	10 x 3 mm	150 mm	4	74.69

JAPANESE FEATHER EDGE SAW FILES

item #	description	\$-net
TL-DF100DA	Japanese diamond feather edge saw file. Can be used as a file or a honer. 100 mm file length, 200 mm overall length. Wood handle.	43.70
TL-DF100	Japanese feather edge saw file. For use as a nut file. 100 mm length. No handle.	24.61
TL-DF150	Japanese feather edge saw file. 150 mm cut.	29.90
TL-DF75DA	Japanese diamond feather edge saw file. 75 mm cut.	37.95

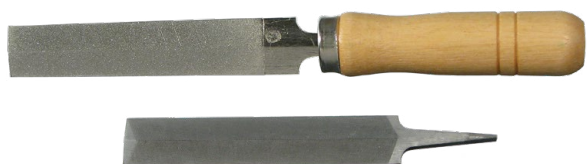

FLAT FILES - FREIDRICH DICK, GERMAN-MADE

SINGLE CUT (for smoothest surface - sharp edges)

number	cross section	cut length	cut	\$-net
704901	21 x 3mm	200 mm	2	12.70
704902	25 x 4mm	250 mm	2	17.39

ALL TOOL PRICES ARE NET!!



GLARDON/VALLORBE SADDLE FILES (FORMERLY GROBET)

Precision files with round edges for violin nuts, saddles & bridges.

no.	thickness	sweep length	sweep	\$-net
705015	0.4 x 10mm	100 mm	2	63.42
705016	0.6 x 10mm	100 mm	2	58.16
705017	0.8 x 10mm	100 mm	2	58.16
705018	1.0 x 10mm	100 mm	2	63.41
705019	Complete Set of 4 files, special price			226.80

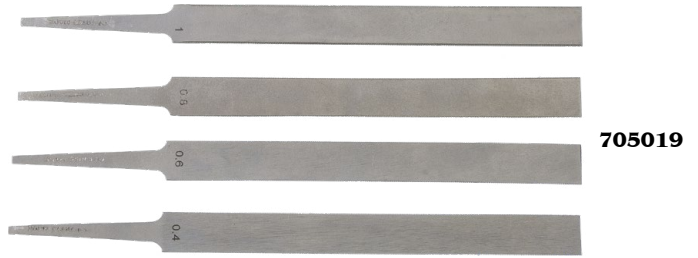
**705019****SADDLE FILES - MADE IN JAPAN**

no.	description	\$-net
T-2451	Set of 4 saddle files.	146.05
T-2452	E string saddle file.	32.20

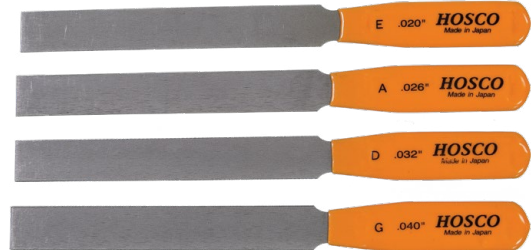
**T-2451****GLARDON/VALLORBE ROUND FILES (FORMERLY GROBET)**

Very slim, finest cut up to the tip. Hardened to 64-65 HRC.

705092, 705093, 705066 & 705057 with square handle.

no.	cross section	cut length	cut	\$-net
705093	∅ 1 mm	50 mm	2	28.39
705066	∅ 1.5 mm	55 mm	2	29.56
705094	∅ 1.5 mm	75 mm	1	39.42
705057	∅ 2.0 mm	65 mm	2	29.63
705097	∅ 4 mm	150 mm	0	47.23
704927	∅ 3.6 mm	100 mm	1	24.52

**704927****GLARDON/VALLORBE NEEDLE FILES (FORMERLY GROBET)**

Knurled handles ∅ 2.9mm, overall length 140 mm, cut length 75 mm. Double cut.

Hardened to 64-66 HRC.

shape	swiss cut 0 (coarse)		swiss cut 1 (fine)	
	no.	\$-net	no.	\$-net
flat	705140	13.36	705040	14.15
triangular	705142	17.06	705042	17.06
square			705043	19.31
round	705144	14.11	705044	15.04
barrette	705145	15.81		
half-round	705146	19.94	705046	18.14
crossing	705147	24.14	705047	21.13
knife shape	705148	17.89	705048	17.54

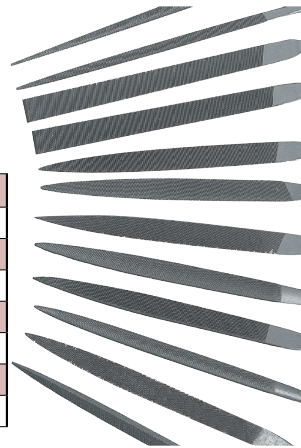
**FILE CARD (FILE CLEANER)**

Brass bristles mounted on beech handle. Overall length: 250 mm.

Brush area: 40 x 100 mm

no.	\$-net
705091	16.65

**MORE NEEDLE FILES**

item #	description	\$-net
GW482800	Needle file, 100 mm length, cut 4.	22.45

**GW482800**

SJÖBERGS WORKBENCHES

"THE PERFECT BENCH FOR THE DISCERNING WOODWORKER"

We are pleased to offer these Swedish-made professional quality workbenches from Sjöbergs! Sjöbergs has more than 90 years of experience in producing workbenches and other equipment.

The Duo workbench is constructed entirely in solid European beech and the two vises can be located in four different positions.

The beech top on the Scandi Plus has two double rows of bench dog holes working from each vise.

THESE ITEMS DO NOT SHIP FROM OUR WAREHOUSE.

**SCANDI PLUS 1425**

Worktop Length:	52 5/8"
Total Length:	57 5/8"
Worktop Width :	22 13/16"
Total Width:	27 15/16"
Worktop Thickness:	1 1/2"
Skirt Thickness:	4 5/16"
Vise Capacity:	4
Weight:	116 lb. 13 oz.

**SCANDI PLUS 1825**

Worktop Length:	70 3/32"
Total Length:	73 5/32"
Worktop Width :	22 13/16"
Total Width:	27 15/16"
Worktop Thickness:	1 1/2"
Skirt Thickness:	4 5/16"
Vise Capacity:	4"
Weight:	138 lb. 14 oz.

**1425 + SM03****SM03****(Item Not Sold Separately)**

TOOLS

Item #	Description	\$-NET
SJ-33280	Scandi Plus Workbench 1425	1,205.00
SJ-33280-33457	Scandi Plus Workbench 1425 plus SM03 Cabinet	1,995.00
SJ-33279	Scandi Plus Workbench 1825.	1,400.00
SJ-33279-33457	Scandi Plus Workbench 1825 plus SM03 Cabinet	2,190.00

SM03 cabinet not sold separately

Sjoberg workbenches do not ship from our warehouse. They are drop-shipped from Michigan. Price includes cost of shipping!

**PLEASE INQUIRE ABOUT
QUANTITY DISCOUNTS**



SHOP APRON

item #	description	\$-net
CORE-APRON	Howard Core Company shop apron.	35.00



HAMMERS

item #	description	\$-net
GW481925	Hammer, for edge inserts.	31.90
481970	Soundpost hammer, with wooden handle. Violin.	23.53
481971	Soundpost hammer, with wooden handle. Cello.	25.96



TOOLS

ORDER ONLINE !!
www.howardcore.com

ALL TOOL PRICES ARE NET!!



HERDIM FINGER PLANES

Small planes with a brass body for shaping the tops and backs of bowed instruments. Slim sides for edge work, and thick sole which users can modify to their own needs, if necessary. Complete with plain blade and wood wedge. Hardened to 60 HRC.

**ARCHED SOLE PLANES**

plane no.	blade width	length of plane	\$-net
702528	4 mm	12 mm	97.46
702530	5 mm	20 mm	58.82
702532	7 mm	25 mm	58.82
702534	10 mm	32 mm	63.06
702536	12 mm	40 mm	69.44
702538	18 mm	50 mm	77.95
702542	23 mm	74 mm	128.60

ARCHED SOLE SPARE BLADES

use with plane no.	blade width	plain blade no.	\$-net	toothed blade no.	\$-net
702528	4 mm	702529	12.41	-----	-----
702530	5 mm	702700	12.81	-----	-----
702532	7 mm	702533	13.94	702541	18.45
702534	10 mm	702702	13.94	702812	21.45
702536	12 mm	702703	14.49	702813	21.85
702538	18 mm	702704	16.94	702814	22.21
702542	23 mm	702705	20.40	702543	28.04

FLAT SOLE PLANES

plane no.	blade width	length of plane	\$-net
702510	5 mm	20 mm	58.82
702512	7 mm	25 mm	61.34
702514	10 mm	32 mm	63.06
702516	12 mm	40 mm	69.44
702518	18 mm	50 mm	79.03
702509	23 mm	74 mm	124.20

FLAT SOLE SPARE BLADES

use with plane no.	blade width	plain blade no.	\$-net	toothed blade no.	\$-net
702510	5 mm	702400	12.81	-----	-----
702512	7 mm	702513	61.34	702540	18.45
702514	10 mm	702402	63.06	702502	21.45
702516	12 mm	702403	14.49	702503	22.40
702518	18 mm	702404	16.94	702504	22.21
702509	23 mm	702405	19.95	-----	-----

**ARCHED SOLE PLANES WITH SCREW CAP**

plane no.	blade width	length of plane	\$-net
702560	5 mm	20 mm	63.06
702561	7 mm	25 mm	63.06
702562	10 mm	32 mm	69.44
702563	12 mm	40 mm	75.81
702564	18 mm	50 mm	84.14
702565	23 mm	74 mm	126.30

FLAT SOLE PLANES WITH SCREW CAP

plane no.	blade width	length of plane	\$-net
702566	5 mm	20 mm	65.11
702567	7 mm	25 mm	63.06
702568	10 mm	32 mm	69.36
702569	12 mm	40 mm	75.81
702570	18 mm	50 mm	84.14
702571	23 mm	74 mm	126.30

SEE ABOVE FOR SPARE BLADES

THE WORLD'S SMALLEST PLANE

Micro plane including case. An original gift for every tool lover. Length 12 mm, blade width 4 mm.

no.	description	\$-net
702527	Micro plane	63.06



ORDER ONLINE !!
www.howardcore.com

ALL TOOL PRICES ARE NET!!

"IBEX" FINGER PLANES

Precision cast, silicon bronze finger planes with accurately guided, screw locked blade. The mouth is located very close to the face for increased corner workability. All planes come complete with blade.



PLANE WITH ARCHED SOLE

plane no.	length x width	\$-net
703301	25 mm 8.0 mm	90.00
703302	30 mm 10.0 mm	94.50
703303	36 mm 12.0 mm	101.70
703304	46 mm 18.0 mm	116.10

SPARE BLADES, ARCHED OR FLAT

plain blade no.	width of blade	\$-net	toothed blade no.	\$-net
703311	8.0 mm	28.80	703321	30.60
703312	10.0 mm	28.80	703322	30.60
703313	12.0 mm	28.80	703323	30.60
703314	18.0 mm	28.80	703324	30.60

PLANE WITH FLAT SOLE

plane no.	length x width	\$-net
703401	25 mm 8.0 mm	90.00
703402	30 mm 10.0 mm	94.50
703403	36 mm 12.0 mm	101.70
703404	47 mm 18.0 mm	116.10
703405	60 mm 22.5 mm	135.00

SPARE BLADE, FLAT

plain plane no.	width of blade	\$-net	toothed blade no.	\$-net
703415	22.5 mm	31.50	703425	31.50

LARGE FINGER PLANES - WITH ADJUSTABLE MOUTH

All planes come complete with plain blades.

PLANE WITH ARCHED SOLE

plane no.	length x width	\$-net
703307	90 mm 27.5 mm	247.50

SPARE BLADE, ARCHED

plain plane no.	width of blade	\$-net	toothed blade no.	\$-net
702717	27.5 mm	36.00	702817	36.00

PLANE WITH FLAT SOLE

plane no.	length x width	\$-net
703306	90 mm 27.5 mm	247.50

SPARE BLADE, FLAT

plain plane no.	width of blade	\$-net	toothed blade no.	\$-net
702716	27.5 mm	36.00	702816	36.00

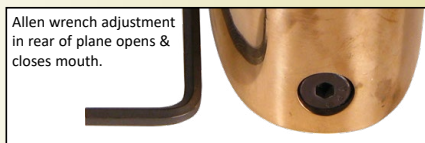

Allen wrench adjustment in rear of plane opens & closes mouth.



702816

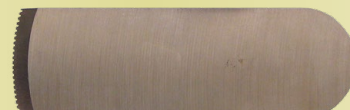

702817



TOOLS

HERDIM NO. 101 PALM PLANE

no.	description	\$-net
702555	No. 101 Palm plane. Brass body with screw cap. Polished handle. 24 mm width, 2.5 mm thickness. Body 85 x 32 mm. 61 RC blade (extra hard). Brass body gives extra heft, avoids rust.	139.06
702556	Replacement blade for #702555.	22.24



702555



TAPE MEASURE - POCKET SIZED!

no.	description	\$-net
707158	Inch/MM scales, 2 meter (over 6.5 ft.) length, ebony casing.	16.36
707160	Like above, with rosewood casing.	15.88
707161	Like above, with boxwood casing.	16.36



RULERS

no.	description	\$-net
RU330	Metal ruler 12" / 30 cm	6.75
RU315	Metal ruler 6" / 15 cm	5.50
717128	Flexible precision rule, 1000 mm. Stainless steel.	60.06
717129	Flexible precision rule, 600 mm. Stainless steel.	37.08
707270	Ultra-flexible ruler. 200 x 13 x .2 mm.	17.44
707271	Ultra-flexible ruler. 300 x 13 x .2 mm.	22.42
707272	Ultra-flexible ruler. 600 x 13 x .2 mm.	50.32

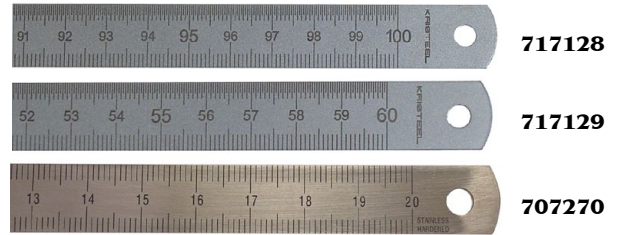

RU 315



RU 330

MARKING & MEASURING TOOLS, TEMPLATES

item #	description	\$-net
GW485052	Straight edge. Steel with rounded edge, without calibration. 50 cm.	42.39
707176	Variable angle bevel. 95 mm length. Hardened steel edge, rosewood handle w/ brass fittings.	28.05
GW485065	Square. 60 x 40 mm. With lock.	31.79
707245	Try Square. Small try square made from tool steel (not stainless). Accuracy 0.08 mm per 100 mm.	31.22
485082	Protractor. Calibration 1° - 180°. Metal.	31.91
GW486300	Bridge templates, for violin, viola, & cello. Set of 6.	212.63

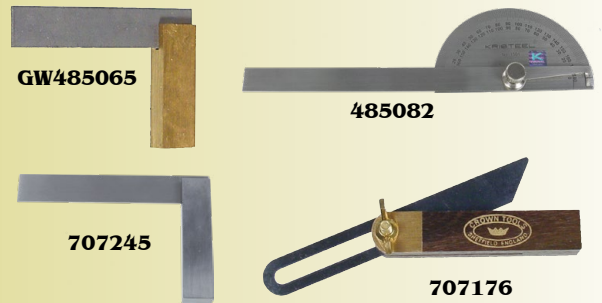

FIQUET COMPASSES

Solid steel with ground, hardened points and brass fittings. Compasses have quick-acting adjustment screws.

no	description	"A" Qual. \$-net	"B" Qual. \$-net
707150	Compass divider. Leg length 150 mm. Max. opening 160 mm.	36.49	26.92
707151	Same as above, with pencil holder.	48.19	-----
707153	Inside caliper. Leg length 150 mm. Max. opening 190 mm, min. opening 25 mm.	36.39	26.92



PLEASE INQUIRE ABOUT QUANTITY DISCOUNTS



TOOLS

MINI SLIDE CALIPER

no	description	\$-net
707243	Precision caliper for taking inside and outside measurements on small objects, models, veneers, etc. Its light weight and compact size make it ideal for measuring delicate objects. Stainless steel, deep-etched scale with 0.05 mm vernier. Measuring range up to 70 mm, tip length 20 mm, weight 23 g.	36.43



ELECTRONIC CALIPER

no	description	\$-net
707170	Measures up to 150 mm, tip length 40 mm. Measures inside, outside & depth, with mm/inch option. Stainless steel beam & slide. 5 digit LCD display. Zeroing switch. Resolution: 0.01 mm.	64.33
707258	Like above, measures up to 100 mm. 30 mm tip.	67.28

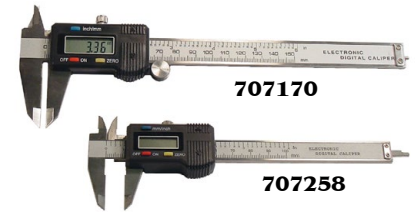

DIAL CALIPER

no	description	\$-net
707259	Sturdy dial caliper with shock- and dust-proof analog indicator. Stainless steel slide and dial. Accurate to within 0.01 mm. Measuring length 150 mm. Tip length 40 mm.	81.31



LARGE CALIPERS (and Parts)

no.	pin head	graduation	jaw depth	\$-net	
707101	Violin	D	0.10 mm	200 mm	406.26
707102	Cello	D	0.10 mm	300 mm	482.34

no	description	\$-net
707116	Replacement dial for nos. 707101-02.	154.07
707106	Pin Head D, 2 piece set, for 707101 & 707102. Ø 10 mm.	53.81
707107	Pin Head E, 2 piece set, for 707101 & 707102. Ø 5 mm.	25.90
707100	MADE IN USA. Use for violin AND cello! Same German dial as 707116. Graduating caliper; extremely rigid die cast aluminum frame, unique top lifting lever allows unrestricted measuring. 32 cm throat, measures to 30 mm. Dial gauge reads to 0.1 mm. American made.	360.00
707105	Small graduating caliper, machined alum. frame. 23 cm throat, measures to 30 mm. Dial gauge reads to 0.1 mm. Assembled in USA.	360.00
T50100	Marking calipers, violin, viola, & cello. 9" throat.	225.00
707088	Caliper for measuring over the ribs - violin, viola, cello.	377.16
707001	String projection gauge with digital indicator. Violin / viola.	154.13
707002	String projection gauge with digital indicator. Cello / bass.	255.65

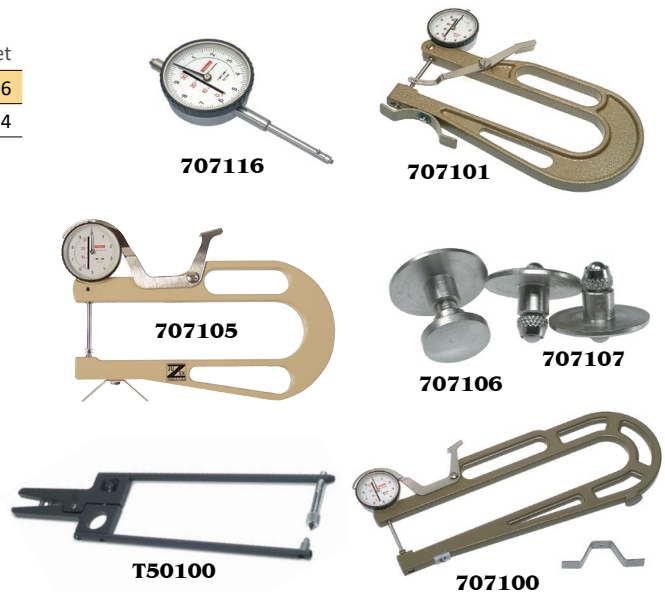

TOOLS



CUTTING GAUGE

item #	description	\$-net
GW481917	For cutting borders, purflings, etc. Measuring scale up to 60 mm. Working scale 0 - 120 mm.	44.32



ITEM # MMKR-70 ACRYLIC/PLASTIC RESTORAL KIT

One each 3"x 6" sheet (1,500, 1,800, 2,400, 3,600, 4,000, 6,000)
 One 3"x 3" Foam Block
 One 2oz. bottle MicroGloss liquid abrasive
 Two flannel sheets

For restoration of scratched, discolored or damaged fiberglass, acrylics or resins, etc. Colored and clear acrylics are repaired the same way: sand out the damage with fine sandpaper and then follow the Micro-mesh series to achieve a high-gloss finish. Kit provides all that is needed to repair minor scratches, discoloration and surface irregularities to restore optical clarity.

For deep scratches or holes, resin* and sandpaper* may be necessary in order to do a proper repair job. Fill holes with resin*, sand smooth with sandpaper*, and polish out with Micro-mesh. * not included in kit

Kit complete - \$ 28.83 net

**"WOODWORKER'S KIT" - ITEM # MMWOODKIT**

Two each 3"x 6" sheet (1500, 1800, 2400, 3200, 3600, 4000, 6000, 8000, 12,000).
 One 3" Foam Block

For superior finishes on bare hardwoods and wood finishes. Use on bare woods to obtain the smoothest finish possible. Oil the wood to preserve the finish and protect the wood, then polish with Micro-mesh to obtain the final finish. Replaces steel wool, pumice, or Rottenstone. When using on finishes (urethanes, epoxies, resins, etc.), sand the surface smooth with a coarse grit and polish out with the rest of the series. Polish out all the way to 12,000 for a high-gloss finish or stop earlier for a more subdued finish.

Kit complete - \$ 58.79 net

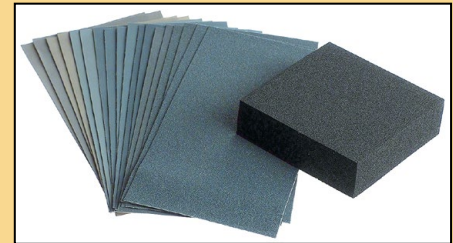
**"HOBBY KIT" - ITEM # MMHOBBYKIT**

One each 3"x 4" sheet
 (2400, 3200, 3600, 4000, 6000, 8000).
 One 2"x 3" Foam Block.
 One 1 oz. bottle Micro-gloss liquid abrasive
 One cotton flannel sheet

A small kit designed for a variety of jobs ranging from polishing wood and golf clubs, cultured marble to acrylics and painted finishes. All of our most popular grits and Micro-gloss to suit a wide variety of tasks. An excellent starter kit to acquaint you with the product and just the right size for your workbench. Polishes just about any surface to a high lustre.

Kit complete - \$ 22.08 net

MICRO-MESH REGULAR

For polishing of acrylics, plastic, fiberglass, epoxy, polyurethane, painted surfaces, gel coat, varnish, wood and other fine finishes. Acrylics, automotive finishes, boats, furniture, gun stocks and violins are specific applications. We are pleased to offer these cushioned abrasives which are so useful in the shop. MICRO-MESH is used by many of the finest violin shops and all highly recommend it.

- Available in the kits shown, you can also save money by purchasing the various meshes in 6"x 12" pieces.

- Meshes: 1500, 1800, 2400, 3200, 3600, 4000, 6000, 8000 and 12,000. 1500 is coarse; 12,000 is super fine.

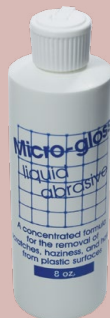

no	description	\$-net
MM1500	1500 Grit coarse	7.73
MM1800	1800 Grit coarse	7.73
MM2400	2400 Grit	7.73
MM3200	3200 Grit	7.73
MM3600	3600 Grit	7.73
MM4000	4000 Grit	7.73
MM6000	6000 Grit	7.73
MM8000	8000 Grit fine	7.73
MM12000	12000 Grit fine	7.73
MMBLOCK	Foam block 3" x 3"	3.29
MMCREAM	Anti-static cream 8	10.64
MMFILE	Nail file 3 grits	1.31
MMPOLISH	Micro-gloss polish 8 oz.	14.49



COPING SAWS

no	description	\$-net
712512	Chromium-plated steel frame, spiral wire blade. 165 mm blade length. Comfortable grip. Comes with two replacement blades.	24.52
712513	Two replacement spiral wire blades.	8.05
712517	Japanese coping saw. With its 250 mm depth, this Japanese coping saw is perfectly suited for deep cuts. Includes three replacement blades with 0.4 mm blade thickness. Blade length 130 mm.	54.39

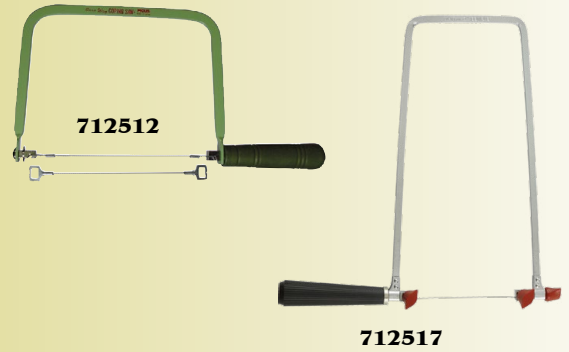

GLARDON JEWELER'S SAW - REPLACEMENT BLADES

no	description	\$-net
712522	12 repl. blades - fine. Thickness 0.18 mm, rip teeth 0.3 mm, setting 0.21 mm.	10.49
712523	12 repl. blades - medium. Thickness 0.28 mm, rip teeth 0.5 mm, setting 0.32 mm.	8.50
712524	12 repl. blades - coarse. Thickness 0.4 mm, rip teeth 0.8 mm, setting 0.48 mm.	8.72

KATABA RESTAURO SAW

no	description	\$-net
712309	100 mm blade length. Overall length 220 mm. Blade thickness 0.3 mm. Cross-cut tooth spacing 1 mm.	33.05



HANDIWORK BACKSAWS

These saws provide superb control, making them perfect for precision work. The rubberized grip fits comfortably in your hand. For cuts across the grain.

no	description	\$-net
712714	Blade length 150 mm; overall length 295 mm. Thickness 0.35 mm; tooth spacing 1.2 mm.	29.73
712716	Replacement blade for #712714.	16.65



DOZUKI UNIVERSAL SAW

no	description	\$-net
712808	Most popular Japanese saw. Blade length 240 mm, blade depth 50 mm, blade thickness 0.3 mm, tooth spacing 1.5 mm. Wooden handle.	93.48
712908	Replacement blade for 712808, above.	24.65
712812	Ryoba Seiun 300. The largest Ryoba with aggressive crosscut teeth and high-performance rip teeth can even handle strong beams and planks. With its two different tooth patterns, the Ryoba saw ensures optimum cutting performance not only across but also in the direction of the grain, making it the most versatile saw for carpentry and joinery. The thicker saw blade allows backless control and thus cuts of any depth flush to the surface.	92.48
712303	Kugihiki 190 Flush-Cutting Traditional Japanese saw. Professional Kugihiki with extremely thin and flexible blade. Traditional design with wooden handle wrapped in rattan. Blade length 190 mm, overall length 510 mm.	120.98



TOOLS



JAPANESE CHISELS

All "INM" items are factory made, HRC63. "NM" items are hand made, HRC64.

item #	description	\$-net
TL-INM3	Japanese flat chisel, 3 mm width. Overall length 225 mm.	44.85
TL-INM6	Japanese flat chisel, 6 mm width. Overall length 225 mm.	40.25
TL-INM9	Japanese flat chisel, 9 mm width. Overall length 225 mm.	36.80
TL-INM12	Japanese flat chisel, 12 mm width. Overall length 225 mm.	36.80
TL-INM15	Japanese flat chisel, 15 mm width. Overall length 225 mm.	37.95
TL-INM18	Japanese flat chisel, 18 mm width. Overall length 225 mm.	40.25
TL-INM21	Japanese flat chisel, 21 mm width. Overall length 225 mm.	42.55
TL-INM24	Japanese flat chisel, 24 mm width. Overall length 225 mm.	48.30



TL-INM3



TL-INM12



TL-NM12

PFEIL COMPACT GOUGE SET

Swiss-made. Comes with rack made of birch and maple.

no.	description	\$-net
700691	Six pieces. Overall length 200 mm. Blade length 90 mm.	228.79

Included:

- 8 mm width, Sweep 1
- 8 mm width, Sweep 1S flat/skew
- 8 mm width, Sweep 5
- 7 mm width, Sweep 8
- 1 mm width, Sweep 11
- 2 mm width, Sweep 12, V 60°

**CUTTING GAUGE**

item #	description	\$-net
700837	Pfeil sculptor gouge, straight. Blade width: 30mm, blade length: 120mm. Sweep 5	118.84



ORDER ONLINE !!
www.howardcore.com

**PLEASE INQUIRE ABOUT
 QUANTITY DISCOUNTS**



GROOVING GOUGES

Fine Swiss gouges with extended neck and slightly bent, inside bevel spoon-type blade for concave surfaces and archings, i.e. violin tops and backs. Shaft and blade forged in one piece from carbon steel, super-finished and polished. Unvarnished Pearwood handle.

no.	sweep	width	\$-net
701101	8	12 mm	118.86
701102	8	17 mm	140.36
701103	5	30 mm	134.21



JAPANESE FLAT CHISELS (KIRINARI NOMI)

These light push chisels are very popular for delicate paring cuts in cabinet-making, instrument-making and restoration work. Handle: waxed Japanese red oak without hoop. Blade length 70mm. Handle length 95mm. Overall length 260mm; blade thickness 3.0 - 4.5mm.

no.	width	\$-net
710108	3 mm	118.21
710109	6 mm	155.44
710104	12 mm	148.34
710102	18 mm	178.58
710103	24 mm	194.49



SET - 6 pcs. in fine English leather roll. 3-24 mm chisels. SET NO LONGER AVAILABLE - INDIVIDUAL FILES ONLY.

FILE HANDLE

Polished boxwood which is very comfortable and easy on hands, complete with ferrule.

no.	length: 105mm	\$-net
701604	File - ferrule Ø 16 mm, length 70 mm	6.89



701601

ALL TOOL PRICES ARE NET!!



VIOLIN PAN - FELT-COVERED

no.	description	\$-net
481960	Violin pan	121.68



LEATHER INSTRUMENT APRON

no.	\$-net
708000	35.00



FULLY ADJUSTABLE VIOLIN WORK BASE

The wooden work base holds the violin firmly in place. This wooden base is attached to a swivel ball mounted in a metal base that can be attached to the workbench.

no.	description	\$-net
1624-1	Ball clamp support for wooden form and scroll clamp.	447.19
1624-2	Wooden scroll clamp. To be used with 1624-1, above.	98.43
1624-3	Wooden form for violin. To be used with 1624-1, above.	98.43
1624-4	Wooden form for viola. To be used with 1624-1, above.	128.81
1624-5	Wooden form for cello. To be used with 1624-1, above.	260.05

ALL TOOL PRICES ARE NET!!

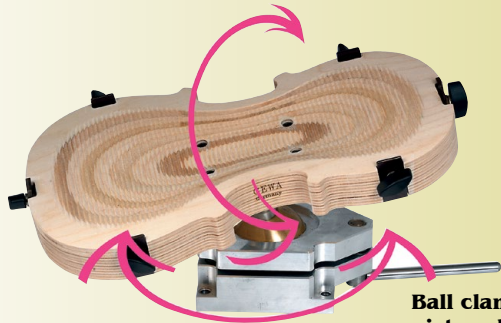

Ball clamp support pictured with violin form attached.



1624-1



1624-2

VIOLIN/VIOLA HOLDER

Fully adjustable to hold any size violin or viola (except largest) for various repair and adjusting procedures such as fingerboard planing, bridge fitting, top crack repairs, stringing, etc. Padded clamp screws hold instrument securely but gently. Black anodized aluminum cradle is mounted on clear plexiglass base. We use these in our shop & highly recommend!

no.	\$-net
T5050	153.00



KAISER CORK FORMS

The new Kaiser Cork form offers violin makers improved and safer handling of their instruments and sets a new standard in the art of violin making. The height ensures that the scroll of the violin never touches the surface of the bench work area. Light and easy to work with, it is also resistant and durable. This repairer's support for violin is a product that will be appreciated by all luthiers, restorers and enthusiasts of the craft of violin making.

no.	description	\$-net
KFI-10	Kaiser cork violin form, extra-high	165.42
KFI-5	Kaiser cork violin form	129.98
KFI-C5	Kaiser cork cello form	342.66



BODY SIZE GAUGE - VIOLIN/VIOLA

no.	\$-net
BSG-VN	23.40



BRIDGE FOOT FITTERS

For assisting in fitting the bridge feet to the top of the instrument.

no.	description	\$-net
T7100	Violin / viola	63.00
T7102	Cello	76.50
T7103	Bass	166.50

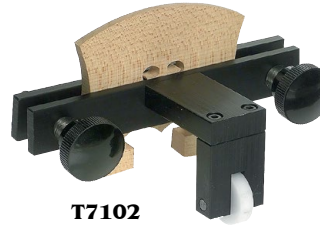

T7102



T7100

HERDIM STRING LIFTERS

The String Lifter is an ideal assistant for exchanging, adjusting and fitting bridges without de-tensioning the strings. Using the String Lifter avoids soundpost dropping and helps positioning the new bridge. The body is made of indestructible fiber-reinforced plastic (vn/va/vc) with grooved support to match varying sizes. The legs are lined with elastic pads to protect the varnish of the instrument. Top piece is serrated to match any string configuration.

no.	description	\$-net
739501	Violin 1/16 - 4/4 & viola. Height 30 - 44 mm.	40.22
739502	Cello 1/8 - 4/4. Height 78 - 100 mm.	49.78
739503	Designed exclusively for basses. Sturdy alloyed aluminum with cork-lined legs. Height 135 - 190 mm.	269.14



739503



739501

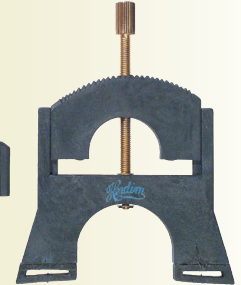

739502

BRIDGE LEG EXPANDERS

To simulate string tension when fitting cello bridges.

no.	description	\$-net
706900	Solid brass	43.02
706901	American made, lighter weight	20.70



706900



706901

BRIDGE MARKER

no.	description	\$-net
707000	Marks string divisions on bridge, 4/4 cello to 1/8 violin.	103.50



BRIDGE THICKNESS GAUGE

no.	description	\$-net
BTG-VN	Bridge Thickness Gauge - Violin/Viola	9.90
BTG-CB	Bridge Thickness Gauge - Cello/Bass	11.70



BTG-VN

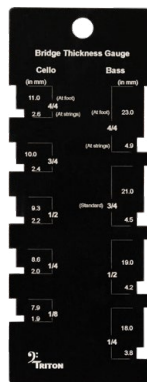

BTG-CB

BRIDGE THICKNESS GAUGE

no.	description	\$-net
SHG-VN	String Height Gauge - Violin	9.90
SHG-VA	String Height Gauge - Viola	9.90
SHG-VC	String Height Gauge - Cello	9.90
SHG-DB	String Height Gauge - Bass	9.90



SHG-VN

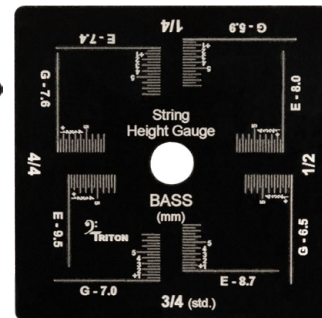

SHG-DB

BRIDGE THICKNESS GAUGE

no.	description	\$-net
SSG-VN	String Spacing Guide @ Nut - Violin	13.50
SSG-CB	String Spacing Guide @ Nut - Cello / Bass	17.10

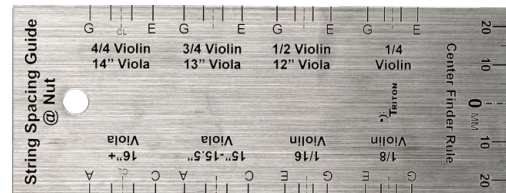

SSG-VN

TOOLS



SOUNDPOST TOOLS

no.	description	\$-net
1	700100 5-notch, stainless steel. Violin.	67.20
2	700101 Violin, stainless steel, American made.	10.35
3	700101-C Cello, stainless steel, American made.	35.10
4	700113 Violin/cello, American made, scissors-style. Stainless steel.	10.35
5	700108 Soundpost retriever, to pull out loose soundpost, for violin.	18.90
6	700109 Soundpost retriever, cello, American-made.	22.50
7	735900 Herdim soundpost setter, hand forged from old English design, rounded edges, finest workmanship, superbly balanced.	75.32
8	700118 Duo soundpost setter, double-layered head, nickel-plated. For violin/viola.	34.43
9	700114 Same as #700118 above, but for small sizes violin (1/8 - 3/4 sizes).	18.06
10	700105 Scissor-style, brass - violin & viola.	21.51
11	700104 German (Ulsa), for bass.	77.85



FORTE SOUNDPOST SETTERS

Stainless steel with rounded edges. Stiff, yet still bendable. Traditional, English-style head is ideal for making fine adjustments in the position of the soundpost. Excellent tapping power due to the hefty head, whose rounded flanks prevent soundpost damage.

no.	description	\$-net
700122	Violin / viola	34.43
700123	Cello	60.94
700124	Bass	73.56



SOUNDPOST GAUGES

Fits through f-hole to measure the internal distance between top and back.

no.	description	\$-net
700110	Violin & viola	23.85
700111	Cello	27.45



INSPECTION MIRROR

no.	description	\$-net
707111	Cello / bass. Bendable. 225 mm length.	23.27



INSPECTION LAMPS

no.	description	\$-net
708001	BEND-A-LIGHT. High intensity light tool with a flexible shaft which puts the light where you need it. The lens gives a brilliant, diffuse light which is ideal for illuminating the interior of violins or other instruments. Complete with extension cover and two batteries.	25.44
708002	Replacement lamp	6.60
708004	Large Bend-A-Light for cellos & basses "Krypton-Pro" - 24".	47.70
708005	Replacement lamp for "Krypton-Pro".	12.72
708006	Replacement switch - fits both sizes.	5.83
708013	Bend-A-Light Mini Pro - 11".	25.44

- length: 400 mm overall with 250 mm flexible shaft
- max. diameter of the shaft: 5 mm
- weight including batteries: 60 g

ORDER ONLINE !!

www.howardcore.com

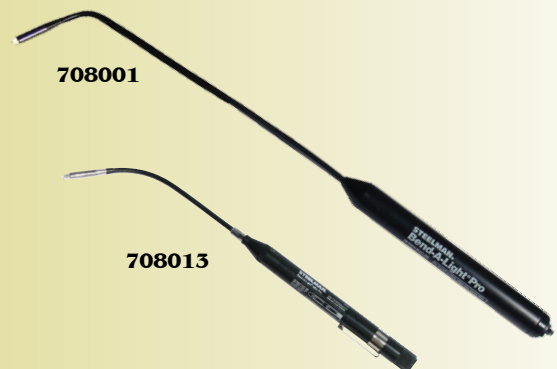

C - CLAMPS

no.	description	\$-net
T-BC01	Depth 90 mm, opening 25 mm. Double swivels, great for bass bars!	31.50
T-BC02	Depth 110 mm, opening 40 mm. Double swivels, great for bass bars!	37.80

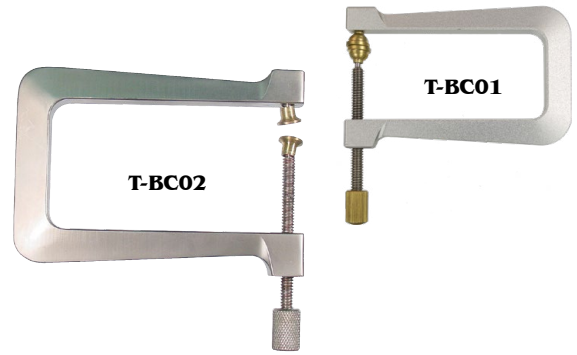

FINGERBOARD PADS

no.	description	\$-net
735810	Rosewood clamping forms to be placed on the top of the fingerboard and the bottom of the neck when gluing the fingerboard to the neck. Set.	13.69
735811	Same as above, for cello.	24.33



PARALLEL CLAMP

Strong steel clamp. Bessey. Opening 28 mm, depth 50 mm.

no.	\$-net
705723	23.03



CLIP CLAMP

Steel, zinc plated, extra strong spring. Length 110 mm, opening 40 mm, depth 40 mm, weight 56g.

no.	\$-net
705861	7.62



TOP CLAMP

For gluing down the top underneath the fingerboard. Machined aluminum. Protective lining.

no.		\$-net
705820	Violin and viola	90.00
705821	Cello	108.00

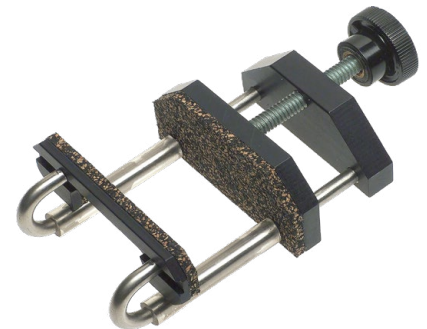

POINTED TWEEZERS

no.	description	\$-net
707141	Pointed tweezers, stainless steel. 110 mm.	7.96



PLEASE INQUIRE ABOUT QUANTITY DISCOUNTS



BESSEY SOLID STEEL BAR CLAMPS

Forged, hardened arm is sturdy yet surprisingly compact and lightweight. Accurately machined bar and arm and hardened threads allow high precision clamping. Perfectly flat, ball-jointed swivel pad, galvanized arm, coated thread, wooden handle.

no.	depth	opening	weight	press plate Ø	\$-net
705780	60 mm	120 mm	300 g	22 mm	40.67
705781	80 mm	160 mm	500 g	25 mm	47.22
705782	100 mm	200 mm	850 g	32 mm	77.69
705783	120 mm	250 mm	1300 g	32 mm	97.58
705784	120 mm	500 mm	2200 g	38 mm	221.74
705785	120 mm	1000 mm	3500 g	38 mm	316.67
705790	Protective strips (2) for Bessey clamps, fits #’s 705780-705782				44.86



705780



705781



705783



705784



705785

Photos not to scale



705790

HERDIM CRACK GLUING CLAMP

Opening 12 mm, depth 5 mm. Galvanized steel. Tightens with M2 hex wrench (not included).

no.	\$-net
705934	8.33

PLEASE INQUIRE ABOUT QUANTITY DISCOUNTS



ALUMINUM REPAIR CLAMPS

Light but strong clamps made of cast aluminum alloy. The foot is slightly elevated to concentrate the pressure and to work on concave surfaces. Steel rod with freely movable swivel in ball bearing.

no.	depth	opening	weight	\$-net
705890	85 mm	35 mm	110g	33.65
705891	120 mm	35 mm	120g	35.79
705892	160 mm	40 mm	220g	39.87
705893	200 mm	50 mm	290g	41.98
705894	Set, 5 pcs., 1 ea. 705890/92/93, 2 x 705891			176.98

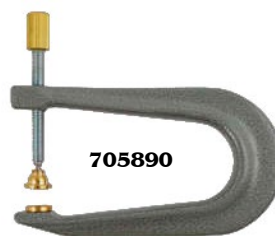

705890



705891



705892



705893

ORDER ONLINE @ www.howardcore.com



TOOLS

"HERDIM" STRUTTED REPAIR CLAMPS

Unique strutted design allows for high stiffness vs. low weight - excellent characteristics for repair clamps used on fine and fragile structures. These two contradictory requirements are nicely combined with this Herdim achievement.

The lower pad is adjustable in height and thus enhances the scope of application. It features an optional self-adhesive rubber cork padding, while the movable parts use the traditional rubber coated movable plate and a precise brass spindle with knurled handle. Steel body with black anodized coating. To protect varnished surfaces, special silicone pads are available as accessories.

no.	depth	opening	weight	\$-net ea.
735720	26 mm	10 mm	12 g	33.65
735722	40 mm	30 mm	36 g	35.44
735728	150 mm	75 mm	190 g	59.71
735729	300 mm	75 mm	568 g	76.18

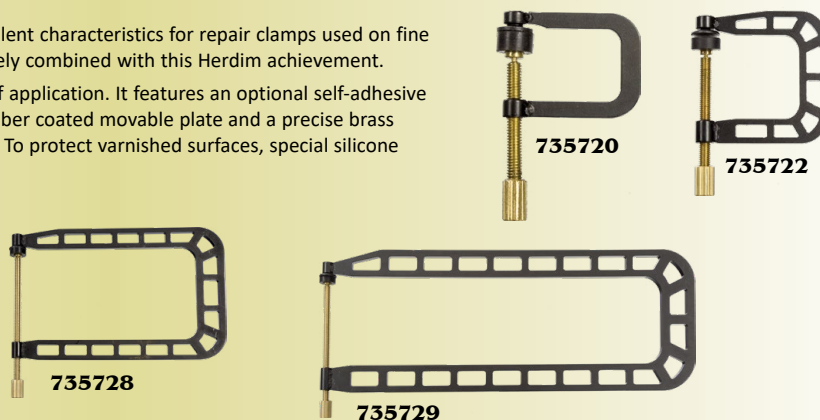

"HERDIM" REPAIR CLAMPS

The finest professional clamps for musical instrument repair, furniture restoration, pattern making and other delicate clamping tasks.

Hand forged steel clamps of high stability and low weight, give well-defined pressure on the parts to be glued. High-pitch rods for fast closing action. Freely mobile brass swivels on ball bearings. All parts galvanized or made from corrosion free, non-staining material.

no.	depth	opening	weight	application	"A" Qual. \$-net	"B" Qual. \$-net	
1	735719	25 mm	10 mm	11 g	micro size clamp	65.69	22.38
2	735718	28 mm	15 mm	18 g	micro clamp	61.67	22.38
3	735714	40 mm	28 mm	35 g	crack-cleating, edging, f-holes, ribs	64.78	22.38
4	735715	90 mm	28 mm	75 g	crack-cleating, ribs	68.80	31.35
5	735702	85 mm	36 mm	115 g	crack-cleating	77.92	33.13
6	735704	135 mm	37 mm	170 g	bass bar, violin, viola	69.36	34.03
7	735707	205 mm	37 mm	300 g	crack-cleating cello, finger-board guitar	84.50	42.77
8	735713	300 mm	70 mm	720 g	crack-cleating bass, top/back cello (plaster repair method)	126.32	59.10
	735709	50 mm	70 mm	105 g	fingerboard violin/cello	70.08	40.10
	735711	145 mm	70 mm	205 g	top/back (plaster repair method)	83.31	52.62

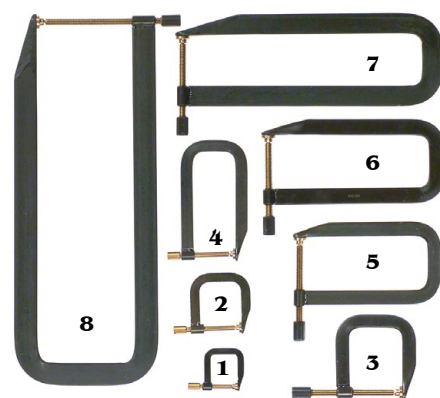

"HERDIM" CRACK CLAMPS

Made for violin, viola, cello and bass.

The new HERDIM Crack clamp has all the features professional stringed instrument repairers have waited for:

- Adjustable, preset working length for quick, versatile use; only 2 sizes cover all applications
- Twisting pad with convex and concave side to adapt to the contour of the instrument.
- Double rod for high specific strength and flexibility.
- With two sliding jack screws for leveling the crack without wedges.

No. 735847 has two sides for repairing a top which has been removed (pressure can be equalized both above & below.)

No. 735848 & 735849 clamp between "F" holes.

no.	description	length	\$-net ea.
705835	Violin/viola	280 mm	73.01
705836	Violin/viola	180 mm	56.78
705838	Cello	300 mm	89.24
735847	Violin/viola with top removed	280 mm	105.45
735808	Herdim® 3-Arm Crack Clamp with Rubber Jaws, Jaw Opening 240 mm. Violin, viola.	240 mm	220.58
735809	Violin/viola between the f-holes.	100 mm	75.81
735819	Better pressure distribution for repairing edges. 240 mm opening.		147.39

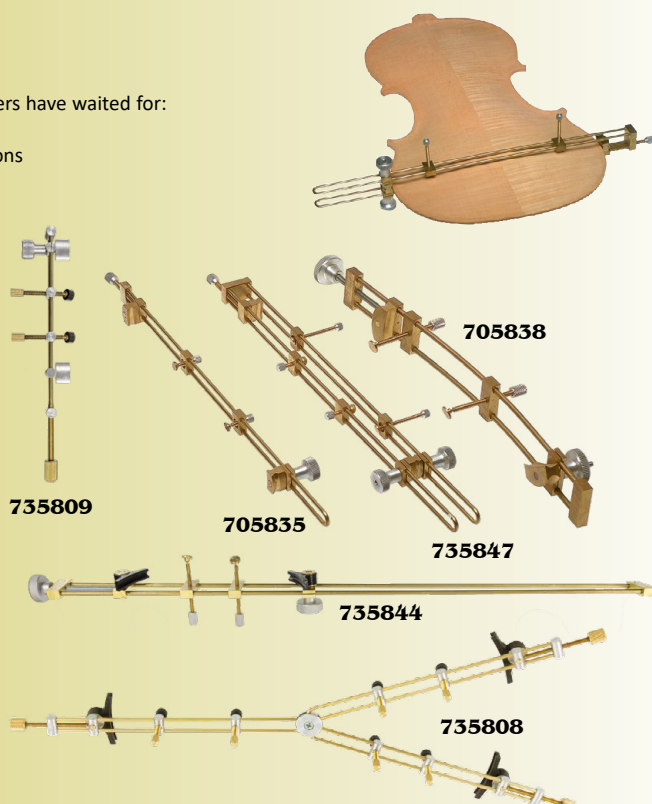

TOOLS



EDGE CLAMPS

For edge repair.

2 brass screws; depth 15 mm, opening 12 mm.

no.	\$-net
705855	50.53



705855

1 brass screw; depth 18mm, opening 15 mm.

no.	\$-net
705856	40.85

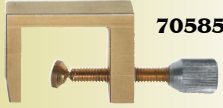

705856

no.	description	\$-net
GW467648	Vertical edge clamp, Swiss model. Vertically & horizontally adjustable, spring guided, 4 screws. Lightweight titanium.	147.70

GW467648



LINING CLAMP

Lining clamps (screw type) for violin and viola. Aluminum with nylon screw. Set of 50 clamps, including 5 feet of reusable backing material. Made in the USA!

item #	description	\$-net
THT-50X5	Set of 50.	159.95



REPAIR CLAMPS

4 parts, straight steel-tension rods with polyamide clamps; flexible.

no.		\$-net
705830	Violin	85.50
705831	Cello	139.50
705832	Bass	136.40



PARALLEL HAND SCREWS

item #	description	\$-net
467116	Parallel hand screws, 40 mm opening, 70 mm depth.	66.47



467116

FINGERBOARD GLUING CLAMP

no.		\$-net
705870	Plastic. For violin, viola and cello.	8.55



LOWER BLOCK CLAMPS

A truly genial clamp for gluing back loose ribs to the lower block without opening the instrument. After the pivot is inserted through the end pin hole, the rod turns by gravity into the cross position. The pad, made from rubber-lined hardwood, has two archings to adapt to different shapes.

Simple, time saving and functional!

no.		"A" Qual. \$-net	"B" Qual. \$-net
735800	Violin	22.80	21.49
735801	Cello	34.68	32.70



CRACK CLAMPS

no.	description	\$-net
T2100A	Edge clamp - draws cracks together at bottom edge; American made.	103.50
T-46017	Most precise clamp cut from titanium & brass – only half as heavy as all brass but more stable! Four screws for best clamping. Exceptional quality. For cello.	291.74
T-46017-B	Like above, for bass.	301.74
467505	Crack clamp, 4 part - violin. Flat profile brass shafts. Moveable, glue-repellant polyamid jaws.	89.24
GW467525	Crack clamp, 4 part - cello. Flat profile brass shafts. Moveable, glue-repellant polyamid jaws.	227.14
GW467555	Crack clamp, 6 part - bass. Flat profile brass shafts. Moveable, glue-repellant polyamid jaws.	301.31
GW467575	Crack clamp for cello. Brass, 3 arms adjustable in length & angle, rotatable jaws.	413.71
GW467620	GEWA-OPTI Crack Repair Clamp System. For gluing horizontal cracks, perfect height compensation. 4 adjustable ball head steel screws on top & base. Violin.	342.66
467576	Gewa crack clamp for bass	440.00

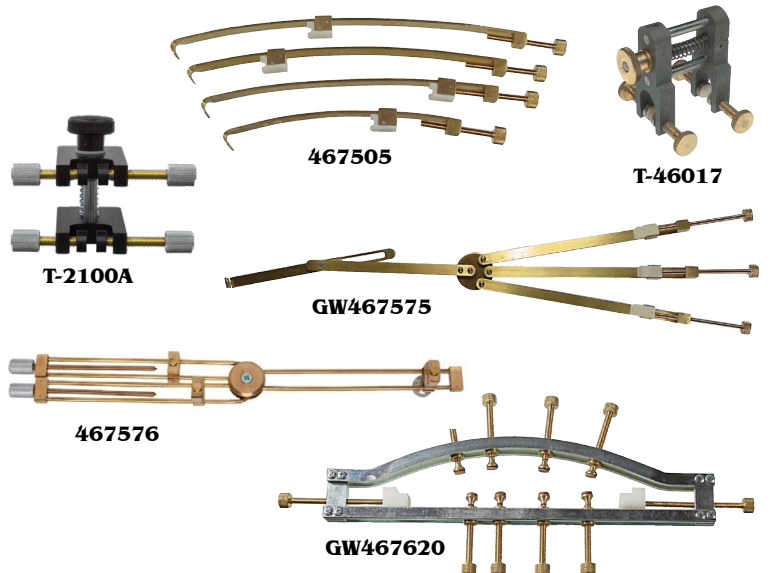

467505

T-46017

T-2100A

GW467575

467576

GW467620

TOOLS



"HERDIM" ASSEMBLY CLAMPS

Gluing the table to the ribs of stringed instruments is a delicate procedure because of the risk of pressure marks and edge chipping. HERDIM Assembly Clamps are designed to eliminate that danger. Their pads go over the ridge of the edge of the violin or cello and exert pressure exactly where it is needed - directly over the rib to avoid any damage to the edge. Because of the precise application the necessary clamp pressure can be considerably reduced, compared to conventional clamps. The material used is glue repelling, non-aging and elastic to avoid pressure marks. The pads are parallel pin guided in a mortice for fast closing action.



VIOLIN / VIOLA

pads: polyurethane, brass bushings
rod: steel, galvanized
nut: brass

no.	color	\$-net
735601	Blue. Lower/upper bout.	23.16
735602	Red. Corners.	24.82
735603	Yellow. Inner bout.	28.06
735600	Set - 32 pcs. (blue - 20; red - 8; yellow - 4)	699.83

CELLO

Precision clamps for cello assembling and repair. Similar to violin version but, due to higher load requirements, the jaws of the cello clamps are made from fiber-reinforced plastic. Herein elastic pads are inserted for an ideal synthesis of strength and surface protection without adding to the weight. The rod is mantled by a silicon tube to protect the edges of the instrument.

pads: fiber reinforced polyamide, brass bushings
rod: steel, galvanized
nut: brass

no.	color	"A" Quality \$-net	"B" Quality \$-net
735631	Blue	32.57	19.70
735632	Red	32.57	19.70
735633	Yellow	32.57	19.70
735630	Set - 42 pcs. (blue - 28; red - 8; yellow - 6)	1,254.36	-----

HERDIM LATERAL CLAMP SPINDLES

The ideal device for applying lateral pressure to the rib area, e.g. for leveling and properly aligning cracked ribs. To be used in conjunction with Herdim Assembly Clamps, above. Spindle with adjustable clamping pad and two locking screws.

no.	\$-net
735605	65.48

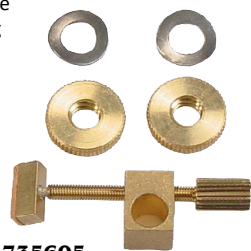

735605

F-HOLE CLAMPS

Fit through the f-hole for cleating cracks without removing the top. Stainless steel profile, steel screw, gun metal finished, leather padded.

no.	depth	opening	\$-net
705801	30mm	30mm	27.00
705802	50mm	30mm	27.00
705803	80mm	30mm	27.00
705804	100mm	30mm	27.00
705800	Set: 4 pcs. (no. 705801-04)		134.39

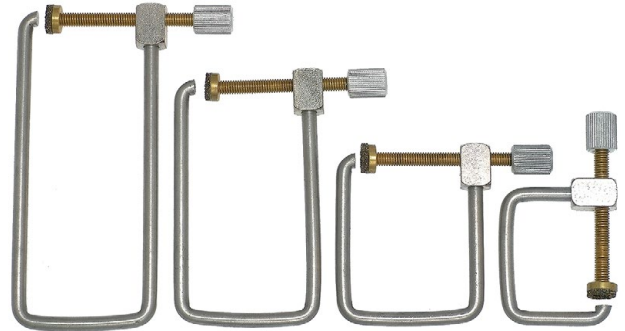

HERDIM RIB CORNER REPAIR CLAMPS

For re-gluing rib corners. Allows precise pressure to be applied directly to both sides of the rib corner.

no.		\$-net
735610	Violin/viola. Opening 50 mm, 4 spindles.	241.10
735615	Cello. Opening 150 mm, 6 spindles.	262.02

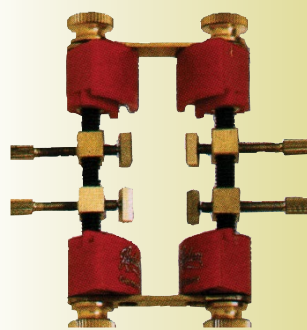

735610

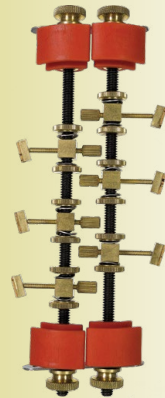

735615

HERDIM ALUMINUM CRACK CLAMP SET

no.		\$-net
735834	Herdim® Aluminium Crack Clamps, Violin, Viola, 4-Piece Set	284.52

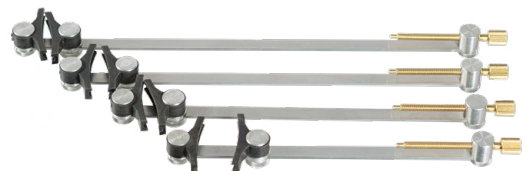

TOOLS



GLUING CLAMPS

no.		\$-net / ea.
705704	Cello & guitar. German made	94.19
705705	Bass. German made	94.19
705706	Violin	11.76
705707	Cello	13.86
705708	Bass	28.36

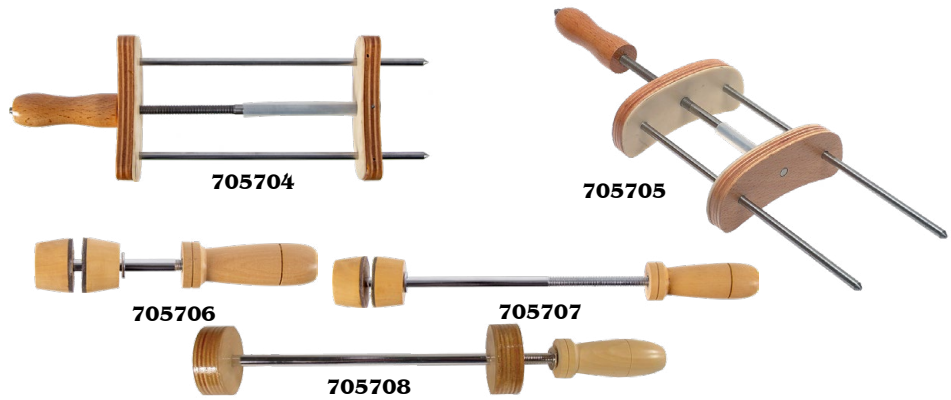

GLUING CLAMP SETS

Hardwood pads with rubber lining.

no.		\$-net
705700	Violin, 6 parts	361.44

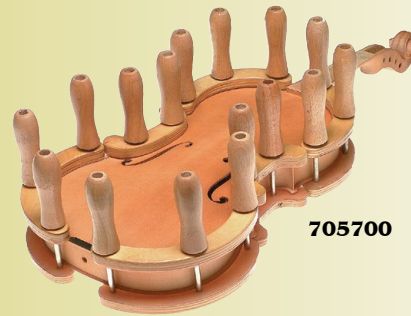

WOOD SCREW CLAMPS

Individual wood screw clamps, or spool clamps.
Leather pads, nickel plated rod.

no.		\$-net
T2110AV	Violin / viola	6.30
T2110AC	Cello	7.65
T2110AB	Bass	10.80

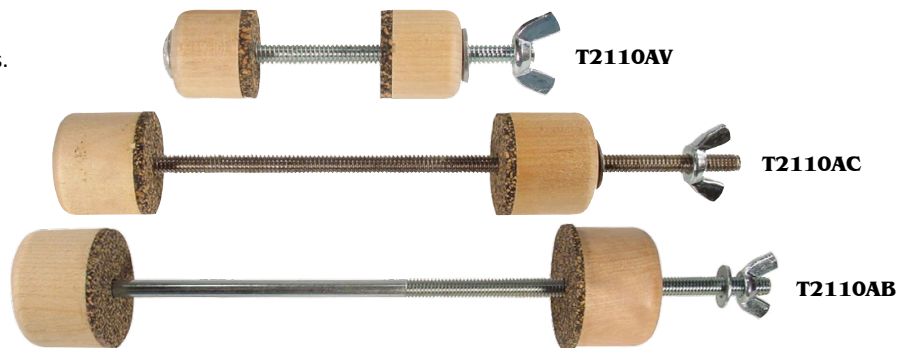

3-WAY CLAMP FOR VIOLIN

Light weight machined aluminum clamp for gluing top down on violin or viola. Swiveled, leather padded tightening screws on top and bottom. Side screw used to properly position rib in case of bulging.

no.	\$-net
T5011	21.60



ALL TOOL PRICES ARE NET!!

PATCHING CLAMP

Lightweight machined aluminum, black anodized finish. Four inch throat with leather padded swivels.

no.	\$-net
PC1500	36.00



WOLF ELIMINATOR CLAMP

Clamp for gluing the wolf eliminator to the interior of the cello. Depth 90 mm, opening 35 mm. Weight 39 gm. The swivel pad is adjustable in height.

no.	\$-net
GW415355	56.72

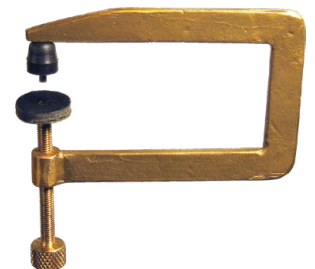

ORDER ONLINE !!
www.howardcore.com



PATTERNS

no.	description	\$-net
T43	Graduation and outline diagram. <i>Specify Strad. or Guarneri model.</i>	1.25
T44	F-hole pattern, PVC. <i>Specify Strad. or Guarneri model.</i>	5.40
T4921N	Neck pattern, PVC.	7.20
T4924	Body pattern, PVC. <i>Specify Strad. or Guarneri model.</i>	7.20
T4919	Neck angle gauge.	20.25



T4921N



T4924-G

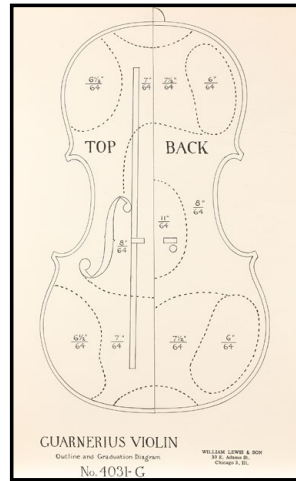

T43-G



T44-S



T4919

ALL TOOL PRICES ARE NET!!

BRIDGE & FINGERBOARD PATTERNS / TEMPLATES

no.	description	\$-net
739400	Herdim precision patterns with tapered spurs at base of bridge patterns for gauging string height. 6-piece set for violin, viola, & cello. 0.5 mm thick stainless steel. Sizes according to Hans Weissshar.	84.14
BT11	Bridge template for violin, 4/4 acrylic.	9.90
BT12	Bridge template, for violin, 3/4 acrylic.	9.90
BT21	Bridge template, for viola, 4/4 acrylic.	10.35
BT31	Bridge template, for cello, 4/4 acrylic.	10.35
BT32	Bridge template, for cello, 3/4 acrylic.	10.35
BT42C	Bridge template, for bass, 3/4 classic.	13.95

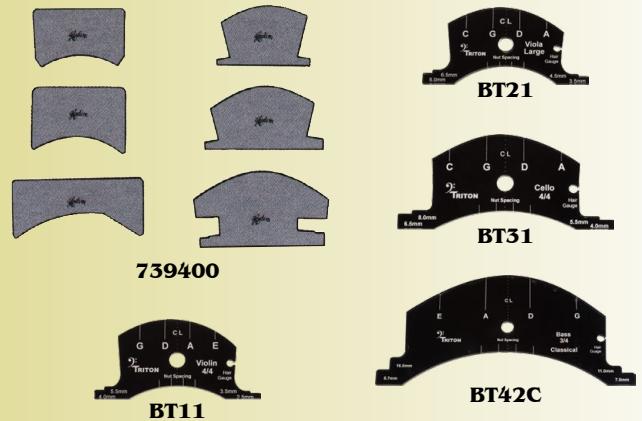

FINGERBOARD CONCAVITY TEMPLATES

no.	description	\$-net
FCT-VN	Fingerboard Concavity Template - Violin 4/4	14.85
FCT-VA	Fingerboard Concavity Template - Viola 4/4	16.65
FCT-VC	Fingerboard Concavity Template - Cello 4/4	26.10



FCT-VN



FCT-VA



FCT-VC

PLEASE INQUIRE ABOUT QUANTITY DISCOUNTS

TOOLS



PURFLING GROOVE CUTTER

no.	description	\$-net
702522	0.5 mm blade, precision adjustable. Precisely machined from a solid brass bar.	96.18
702523	Set of two blades for 702522	34.37
700603	American made with rosewood handle, lbex.	90.00
700604	Set of two (2) replacement blades for #700603.	18.00
702544	Mach One purfling cutter, two blades.	164.01

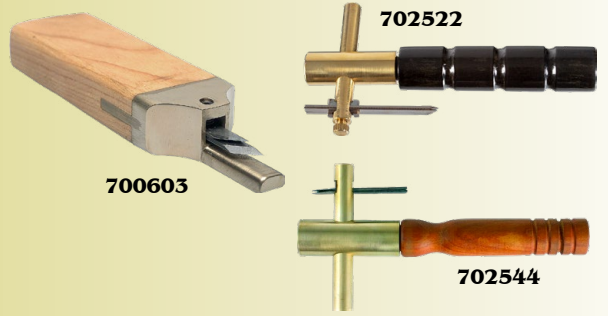

PURFLING CHANNEL CLEANER

no.	description	\$-net
700605	With wooden handle, American made.	18.90
700606	Hardened & polished steel.	21.01
700608	Forged, precision blade. Pfeil.	141.86

SEE PAGE H-5 - ELECTRIC ROUTER FOR CUTTING PURFLING CHANNEL



PURFLING GAUGE

item #	description	\$-net
GW481917	Cutting gauge. For cutting borders, purflings, etc. Measuring scale up to 60 mm. Working scale 0 - 120 mm.	32.83



BENDING IRONS

Universal bending iron for violin, viola, cello & guitar. Rheostat control. Cast aluminum oval shape, mounts horizontal or vertical.

no.	description	\$-net
T105	Universal bending iron for violin, viola, cello & guitar. Rheostat control. Cast aluminum oval shape, mounts horizontal or vertical. 120V, 200W. 4 lbs.	405.00
703912	Bending straps for use with T105, above. Violin / viola. For pressing the ribs against the bending iron. Made of highly flexible, 0.3 mm thick stainless steel fitted with a wire handle on each end. 50 mm x 320 mm.	70.60
703913	Bending straps for use with T105, above. Cello / guitar. 125 mm x 460 mm.	121.74



ALL TOOL PRICES ARE NET!!

STRING WINDERS - DRILL ATTACHMENTS

NOTE THAT MOST ARE LIST PRICED

no.	description	\$-LIST
707206	For guitar.	33.08
BSW1	Plastic bass string winder.	15.62
BSW2	Ebony bass string winder.	36.60
AC270W	Wittner violin/viola/ukulele/guitar	19.88
AC272W	Wittner cello	19.88
NHM-BSTWD	New Harmony bass string winder NET-PRICED	26.25



TOOLS

UPDATES TO TOOLS

PAGE	DATE	EXPLANATION
H20	1-1-2020	MICRO-MESH PRICE INCREASE
H26	2-3-2020	PRICE INCREASE: BEND-A-LIGHTS
MISC	2-3-2020	PRICE INCREASE: MISCELLANEOUS TOOLS
MISC	3-1-2020	PRICE INCREASE: MISCELLANEOUS TOOLS
H7	4-7-2020	ADDED ITEM #4465 (SEAM SEPARATION KNIFE); RE-PURPOSED ITEM #700401 (USED TO BE SEAM SEPARATION KNIFE)
H9		PRICE INCREASE: ITEM # G50
H24		ADDED KAISER CORK FORMS
H7		PRICE CHANGE: SEAM SEPARATION KNIFE #4465
H17	7-10-2020	REMOVED ITEM GW486610 - NO LONGER AVAILABLE
H8	8-18-2020	UPDATED PRICING ITEM #706012
H25	9-1-2020	PRICE INCREASE: ITEM #'s AC270W, AC272W
H3	9-1-2020	PRICE INCREASE: ITEM #'s 730111, 278
H33	11-5-2020	PRICE INCREASE: ITEM #702522
H35	2-1-2021	ITEM SCALE3 NO LONGER AVAILABLE
MISC	3-1-2021	PRICE INCREASE: MOST TOOLS
MISC	4-23-2021	PRICE INCREASE: MANY TOOLS, INCL. HERDIM
H2, H6, H30	6-21-2021	DISCONTINUED: GW466100, 710512, 710516, T-2700
MISC	7-1-2021	PRICE INCREASE: WITTNER PRODUCTS
H18	11-4-2021	ITEM GW485085 NO LONGER AVAILABLE
H19	11-4-2021	PRICE INCREASE: ITEM #707100
H8	11-4-2021	ITEMS 706011 & 706012 NO LONGER AVAILABLE
H8	11-4-2021	NEW ITEM: 09A0284 GLUE POT (REPLACES ITEM 706011)
H18, H23, H25, H26, H27, H30, H32, H33, H35	1-1-2022	PRICE INCREASE: TAPE MEASURES, 701604, BSW2, 706900, MISC. CLAMPS, MISC. SOUNDPOST TOOLS,
H23	1-18-2022	DELUXE JAPANESE SCROLL GOUGES NO LONGER AVAILABLE
MISC	2-1-2022	MISCELLANEOUS PRICE CHANGES
H22	2-9-2022	ITEMS TL-NM6, TL-NM9 NO LONGER AVAILABLE
MISC	2-9-2022	PRICE INCREASE: ITEMS 700104, 705704, 705705, 705832, T-46017
H3, H25	3-23-2022	PRICE CHANGE: WITTNER PRODUCTS
H20	4-29-2022	PRICE CHANGE: MICRO-MESH PRODUCTS
H30	8-26-2022	NEW ITEM: 467576 GEWA CRACK CLAMP FOR BASS
H22	10-20-2022	ITEM #TL-NM12 NO LONGER AVAILABLE
H36-H57	11-13-2022	NEW CORE TOOLS
MISC	1-7-2023	PRICE CHANGE: MISC TOOLS
MISC	2-15-2023	PRICE CHANGE: ULSA TOOLS
H3, H25	3-1-2023	PRICE CHANGE: ITEM #'s 278, 730111; AC270W, AC272W

H6	5-3-2023	PRICE CHANGE: JAPANESE CARVING KNIFE SET #TL-I6S
H12	5-3-2023	PRICE CHANGE: JAPANESE FEATHER EDGE SAW FILES #TL-DF100, TL-DF75DA, TL-DF100DA
H22	5-3-2023	PRICE CHANGE: JAPANESE CHISELS #TL-INM...
H9	9-11-2023	PRICE CHANGE: GW464750, GW464760
H20	1-1-2024	PRICE CHANGE: MICRO-MESH
H36-H77	1-1-2024	UPDATED CORE TOOLS SECTION
H70	1-5-2024	FIXED PHOTO CAPTION ITEM #CT-842.610
H2-H35	2-1-2024	PRICE CHANGE: MISC. AMERICAN-MADE TOOLS
H9, H26	2-22-2024	NO LONGER AVAILABLE: 706125, 706126, 707113
H2-H35	4-8-2024	MISC TOOL PRICE CHANGES
MISC.	4-24-2024	PRICE CHG: ULSA TOOLS
	5-8-2024	MOVE BOWMAKER TOOLS TO BOWPARTS SECTION OF CATALOG
H8	5-29-2024	ITEM #736002 NO LONGER AVAILABLE
H27	8-7-2024	ITEM 705815 NO LONGER AVAILABLE
H63	8-7-2024	ITEM CT-809.138 CHANGE DESCRIPTION
H25	8-27-2024	NEW ITEM: T7103 BASS FOOT FITTER
H3, H25	11-1-2024	PRICE CHG: ALL WITTNER ITEMS
H17, H25, H26, H34	2-1-2025	PRICE CHG: SOME IBEX PLANES, T7103, 700101, T105
H6, H13, H22	2-1-2025	PRICE CHG: SOME HOSCO TOOLS
	5-12-2025	PRICE CHANGE: MOST ITEMS IN THIS SECTION - TARIFF ADJUSTMENT
H57	6-10-2025	NO LONGER AVAILABLE: GW482805
H62	6-10-2025	NO LONGER AVAILABLE: GW485087
H49	8-14-2025	REMOVED: ITEM #'s GW481904 & 907
MISC	8-28-2025	PRICE CHANGE - MISC ITEMS - TARIFF ADJUSTMENQT
H64	10-1-2025	PRICE CHANGE: MICROMESH ITEMS
H48, H51, H66, H72, H73, H77	10-9-2025	PRICE CHANGE: ITEM #'S 700395, 700608, 700837, 700398-399, 702544, 735808
H49	10-9-2025	PRICE REDUCED - GW481902
H53	10-10-2025	PRICE CHG: ITEM #G50
H53	1-14-2026	NEW ITEMS: G50-411, G50-192, G50-251
MISC	1-30-2026	PRICE CHG: IBEX PLANES, MISC AMERICAN-MADE ITEMS
H50, H56, H57, H66	2-18-2026	PRICE CHG: T-2451 & 2; TOOLS BEGINNING WITH "TL-"
H74	6-12-2026	NEW ITEM: 806497 LINING CLAMPS

TOOLS

